



21 Series Lathe Operation

Manual

Date: 2015/11/13

Version: 1.3

Contents

1	FUNCTION KEY AND SYSTEM CONFIGURATION	4
1.1	MAIN SCREEN SECTIONS	5
1.2	CNC SYSTEM CONFIGURATION	6
1.3	COORDINATE.....	7
1.3.1	Explanation of Function.....	8
1.3.2	Switch Coordinate.....	9
1.3.3	Half Coordinate.....	9
1.3.4	Clear Rel. Coord.	10
1.3.5	Clear All Rel. Coord.	11
1.4	PROGRAM.....	12
1.4.1	Execute.....	14
1.4.2	Delete Line.....	14
1.4.3	Search/Replace.....	15
1.4.4	File Manager	18
1.4.5	Simulation	29
1.4.6	Can Cycle	37
1.4.7	Block Copy.....	40
1.4.8	Teach.....	44
1.5	OFFSET/SETTING	48
1.5.1	Tool Wear Set	49
1.5.2	Tool Length Set.....	50
1.5.3	Tool Nose Set.....	51
1.5.4	User Parameter Setting.....	53
1.5.5	Working Shift.....	54
1.5.6	Work Piece Cord.	55
1.6	MONITOR	60
1.6.1	Monitor Area of Machining Information.....	62
1.6.2	Display Area of Machining Setting	65
1.6.3	Simulation Graph	67
1.6.4	Open File to Edit.....	68
1.6.5	Simulation Switch.....	68
1.6.6	MDI Input.....	68
1.6.7	Parameter Set	69
1.6.8	Tool Wear Set	69

1.6.9	Work Record	69
1.6.10	Clear Accum Cycle time	70
1.6.11	Graph Adjust	71
1.7	MAINTAIN	72
1.7.1	Alarm.....	73
1.7.2	Network Setting	75
1.7.3	Fast Diagnostic.....	79
1.7.4	PLC Param Setting.....	82
1.7.5	System Setting.....	84
1.7.6	Backup System.....	86
1.7.7	System permissions.....	86
1.7.8	User Login.....	88
1.7.9	User Logout.....	89
1.7.10	Forget Password.....	89
1.7.11	Authority Management	89
1.7.12	Reset Password	91
1.7.13	About.....	92
2	MACHINE OPERATION PANEL	93
2.1	OPERATION PANEL.....	94
2.2	TEXT KEY DESCRIPTION	102
3	HOW TO OPERATE 21 SERIES CONTROLLER	104
3.1	SYSTEM STATUS.....	105
3.1.1	Not Ready.....	105
3.1.2	Ready.....	105
3.1.3	Busy.....	105
3.1.4	Feed Hold	105
3.1.5	B-stop	105
3.2	MACHINE PREPARATION	106
3.2.1	Manual Function	106
3.2.2	Machining Process	109
3.2.3	HOME	110
3.3	TOOL PREPARATION.....	111
3.3.1	Tool Length Set.....	112
3.3.2	Tool Length Measurement	114
3.3.3	Working Shift.....	123
3.3.4	Tool Manager Function.....	125
3.4	PROGRAM PREPARATION AND EXECUTE MACHINING	128

3.4.1	Specifying Machining Program	128
3.4.2	Simu. Setting	129
3.4.3	Machining Test	131
3.4.4	Machining Monitor	133
3.5	ALARM PROCESSING	135
3.5.1	Emergency Stop	135
3.5.2	Alarm Display	135
3.5.3	Save Alarm.....	136
3.6	NETWORK SETTING	137
3.7	PC SETTING	138
3.7.1	XP OS.....	138
3.7.2	VISTA OS	142
3.7.3	Win 7 OS.....	146
3.8	FILE TRANSFER	150
3.8.1	File Import.....	151
3.8.2	File Export.....	152
4	APPENDIX.....	153
4.1	RELEASE NOTE	153
4.2	CONTACT WINDOW.....	154

1 Function Key and System configuration

1.1 Main Screen Sections

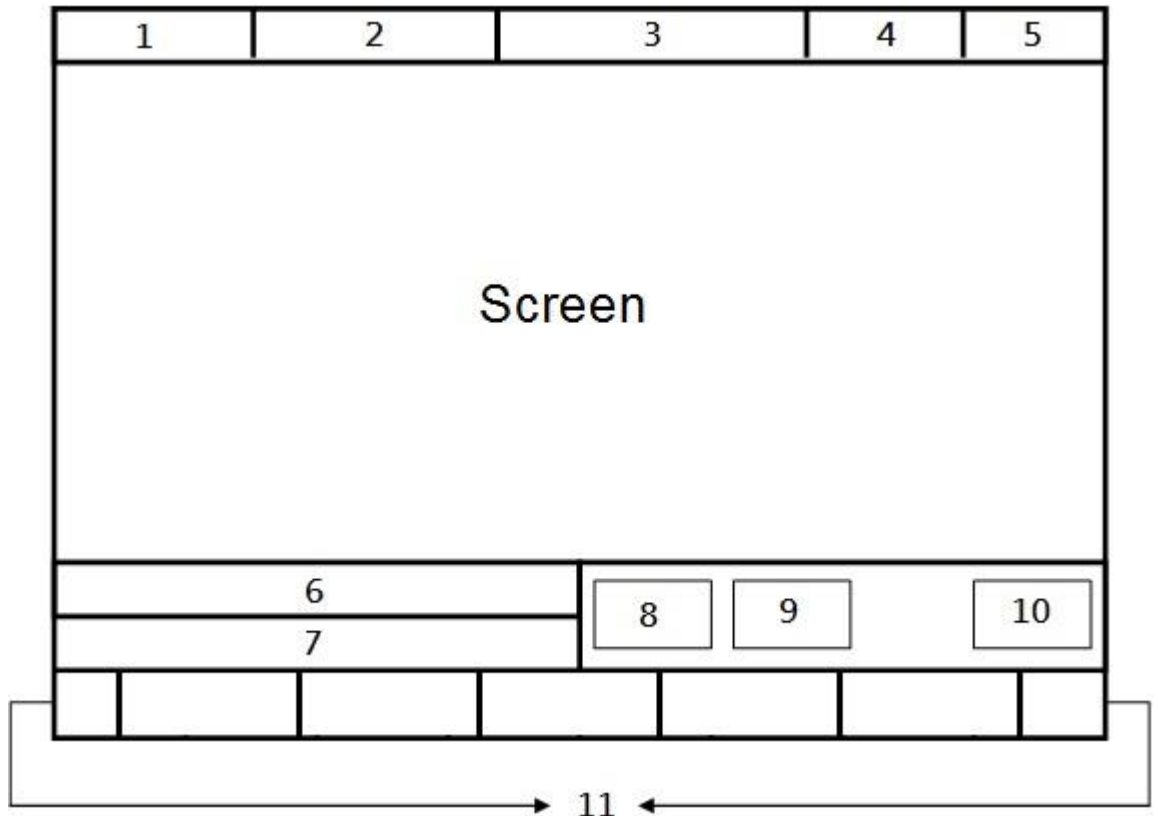

- Meanings for Sections on the Display:
 1. Present coordinate system
 2. Working file name and machining command line
 3. Title of interface
 4. Date
 5. Time
 6. Data input
 7. Display(Hint)
 8. Status
 9. Mode
 10. Alarm
 11. Function Key Switch

1.2 CNC System Configuration

5 buttons

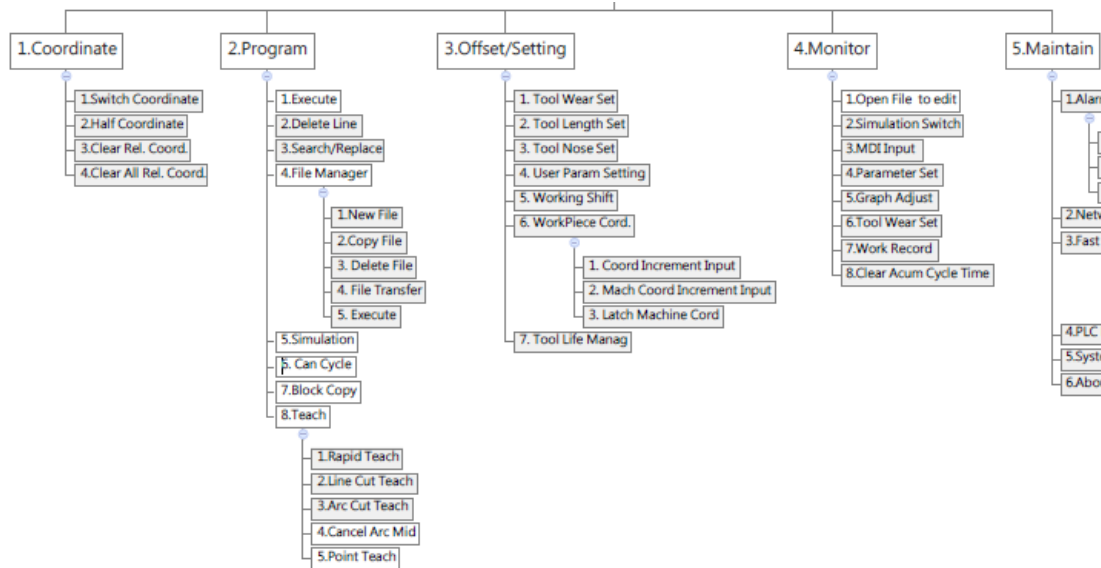

8 buttons

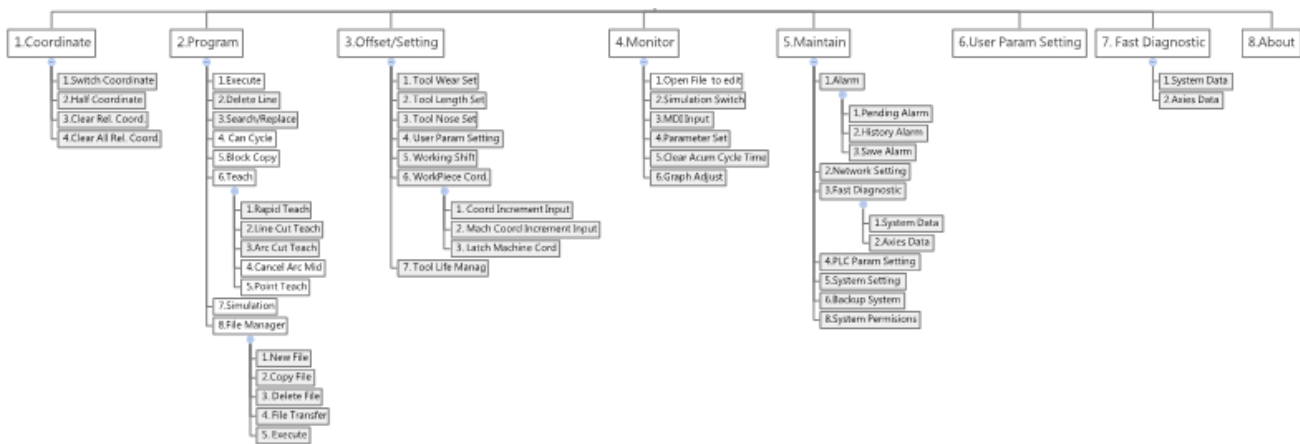

1.3 Coordinate

054	ATEST-161 N0 L1	Coordinate	2013/7/2	15:08:47
<p>Machine</p> <p>X 0.000</p> <p>Y 0.000</p> <p>Z 0.000</p>			<p>Relative</p> <p>X 0.000</p> <p>Y 0.000</p> <p>Z 0.000</p>	
<p>F 1000.000mm/min 100 %</p> <p>0.0mm/min (Actual)</p>			<p>S 0RPM 0 %</p> <p>0RPM (Actual)</p>	
<p>Run Time 0 : 0 : 0</p>			<p>PartCou 0 T 0</p>	
			<p>Absolute</p> <p>X 0.000</p> <p>Y 0.000</p> <p>Z 0.000</p>	
			<p>Dist. To Go</p> <p>X 0.000</p> <p>Y 0.000</p> <p>Z 0.000</p>	
			<p>Ready Auto Alarm</p>	

- Path

- ✧ F1 Coordinate

- Function

- ✧ Switch current coordinate system on the screen.
 - ✧ Display the frequently use machining information.
 - ✧ Use the group function key **【POS】** , can switch to the current page quickly.

1.3.1 Explanation of Function

1.3.1.1 Coordinate Display

- ✧ Current screen can display 4 kind of coordinate system.
- ✧ Whenever users press F1[↑] Switch Coordinate function key, the coordinate on the screen will switch between four different kinds of coordinates.

1.3.1.2 F(Feedrate)

- ✧ User defines Feedrate (mm/min).
- ✧ Actual Feedrate of cutting tool (mm/min).
- ✧ Percentages of Feedrate that user define.

1.3.1.3 S (Rotating Speed of Spindle)

- ✧ User defines Spindle speed (RPM).
- ✧ Actual speed of spindle (mm/min).
- ✧ Percentages of Spindle speed that user define.

1.3.1.4 Run Time

- ✧ Timer for the execution of program.

1.3.1.5 Part counter

- ✧ Number of parts that had been finished.

1.3.1.6 T(Tool No.)

- ✧ Current Tool no. and Tool compensation no.

1.3.2 Switch Coordinate

- path
 - ✧ F1 Coordinate→F1 switch coordinate
- Function
 - ✧ Whenever users press F1「 Switch Coordinate 」function key, the coordinate display on the screen will switch between four different kinds of coordinates.

1.3.3 Half Coordinate

- Path
 - ✧ F1 Coordinate→F2 Half Coordinate
- Function
 - ✧ Relative coordinate divided by 2.
 - ✧ Co-operate with 「 Clear Rel. Coord. 」 function , this function can quickly calculate the middle point of the object.
- Operation Method
 - ✧ Enter the axis that you want to calculate and then press 「 Half Coordinate 」 .
- Example
 - ✧ Current Rel.Coord.of X axis is 10.000.
 - ✧ Enter 「 X 」 ,and then press 「 half coordinate 」 .
 - ✧ Current Rel. Coord. of X axis Will become 5.000.

1.3.4 Clear Rel. Coord.

- path

- ✧ F1 Coordinate→F3 Clear Rel. Coord.

- Function

- ✧ Set the Relative Coordinate to zero.

- Operation Method

- ✧ Enter the axis that you want to calculate and then
press 「 Clear Rel. Coord. 」

- Example

- ✧ Current Rel.Coord.of X axis is 10.000.

- ✧ Enter 「 X 」 ,and then press 「 Clear Rel. Coord. 」 .

- ✧ Current Rel. Coord. of X axis Will become 0.000.

1.3.5 Clear All Rel. Coord.

- path

- ✧ F1 Coordinate→F4 Clear All Rel. Coord.

- Function

- ✧ Clear all Relative Coordinate.

- Example

- ✧ Current X axis of relative coordinate is 10.000, Y axis is 5.000.

- ✧ Press 「Clear All Rel. Coord.」 function key.

- ✧ Relative Coordinate of X and Y will become 0.000.

1.4 Program



- Path

- ✧ F2 Program

- Function

- ✧ This function provides users program management and editing functions.

- Operation Method

- ✧ Users can use 【↑】 【↓】 【←】 【→】 key to move the cursor to anywhere on the screen for editing purpose.

- ✧ Press 【Page Up】 【Page Down】 to switch the pages.

- ✧ With【Home】【End】can let the cursor switch between the top and end of the line.

- ✧ With the group function key 【Prog/File】 can quickly switch between 「Program」 and 「File Manager」.

1.4.1 Execute

- Path

- ✧ F2 Program→F1 Execute

- Function

- ✧ This function can assign the current editing program as the executive program and also change the monitor to the 「Monitor」 page.

- Note

- ✧ This function will be disabled when machining.

1.4.2 Delete Line

- Path

- ✧ F2 Program→F2 Delete Line

- Function

- ✧ Delete a line where the cursor is located.

1.4.3 Search/Replace

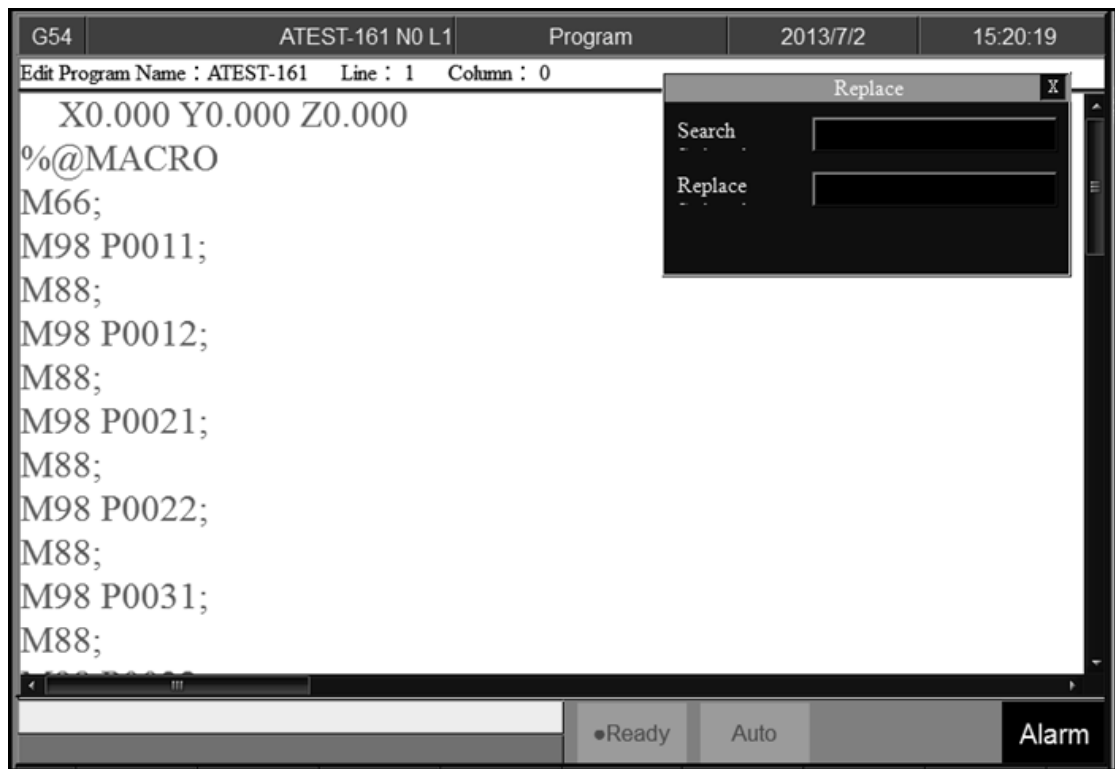

- Path

- ✧ F2 Program→F3 Search/Replace

- Function

- ✧ This function can help to find and replace the string within the editing program.
 - ✧ Press 「 Search/Replace 」 function key, a dialog box will appear to ask users input a string that need to find and replace for.

- Operation Method

- ✧ With 【ENTER】 key, can change the cursor location between 「 Search 」 and 「 Replace 」 .

1.4.3.1 Find Next

- Path

- ✧ F2 Program→F3 Search/Replace→F1 Find Next

- Function

- ✧ According to the 「 Search String 」 , find the next same string within the current editing program.

- ✧ Cursor will move the next same string and the string will be highlight.

1.4.3.2 Replace

- Path

- ✧ F2 Program→F3 Search/Replace→F2 Replace

- Function

- ✧ According to the 「 Search String 」 , find the next same string within the current editing program and replace with the 「 Replace String 」

- Operation Method

- ✧ If there's no highlight string on the screen, press 「 Find Next 」 .

- ✧ Press F2 「 Replace 」 will replace the current highlight string with new string and also cursor will go to the next same 「 Search String 」 .

- ✧ If you want to skip the current highlight string, press F1 「 Find Next 」 .

1.4.3.3 **Replace All**

- Path

- ✧ F2 Program→F3 Search/Replace→F3 Replace All

- Function

- ✧ Replace all of the string defined in 「Search String」 by new string and move the cursor to the line of last string.

1.4.3.4 **Modify Setting**

- Path

- ✧ F2 Program→F3 Search/Replace→F4 Modify Setting

- Function

- ✧ Reset the 「Search/Replace」 string.

- Operation Method

- ✧ After executing 「Find Next」/ 「Replace」/ 「Replace All」, Cursor will be switched to the program edit screen.

- ✧ Press F4 「Modify Setting」 to reset the 「Search/Replace」 string.

1.4.4 File Manager

G54		ATEST-161 N0 L1		File Manager		2013/7/2		15:52:57	
DiskC2:\OpenCNC\NcFiles Free Space: 144506093KB									
Name	Size	Modified	Comment						
0318-lathe	215	2013/03/19 14:33:09	G00 X20.0 Z5.0;						
0318-Lesson	269	2013/03/18 16:24:18	G90 G00 X0. Y0. Z10.;						
0318-Lesson-polar	212	2013/04/18 17:18:39	G90 G00 X11.76. Y16.18. Z10.;						
ATEST-161	421	2013/06/28 18:57:17	X0.000 Y0.000 Z0.000						
Bug-0411	61	2013/04/11 21:11:37	G00 A10. Y10. Z0.						
G0201	86	2013/03/29 15:18:18	%@MACRO						
G0300	855	2013/04/01 11:35:53	%@MACRO						
kp-c d6r0.nc	241657	2011/05/16 15:02:32	%//Bottle Base Rough Cut						
M0066	376	2013/06/14 17:30:11	%@MACRO						
M0088	471	2013/06/14 17:30:49	%@MACRO						
Marco_hw1	288	2013/04/02 10:56:15	%@MACRO						
Marco_hw3	61	2013/03/28 22:10:58	%@MACRO						
Marco_hw4	34	2013/04/01 11:37:16	G54 G90						
MDIBlock	2	2013/04/16 15:45:51							
O0003	23	2013/04/02 21:19:24	%@MARCO						
O0010	210	2013/04/18 14:52:17	% @MACRO						
O0011	26	2013/06/14 17:20:27	%@MACRO						
O0012	25	2013/06/14 17:21:10	%@MACRO						
O0900	177	2012/06/08 10:38:26	% @MACRO						
O1234	32	2013/03/27 21:39:19	O1234;						
O5555 NC	226	2013/03/29 11:03:43							

●Ready Auto Alarm

- Path

- ✧ 5 Buttons type: F2 Program→F4 File Manager
- ✧ 8 Buttons type: F2 Program→F8 File Manager

- Function

- ✧ This function key can manage all of the NC files in data storage device set by Pr3213.

- Operation Method

- ✧ Use **【↑】** **【↓】** key to move the cursor to anywhere on the screen for editing purpose.
- ✧ **【Page Up】** **【Page Down】** to switch the cursor between pages.

- ✧ Press **【ENTER】** key to assign the current cursor file as the executed file, screen will display the program content and user can edit the program.

1.4.4.1 New File

- Path

- ✧ 5 Buttons type: F2 Program→F4 File Manager→F1
New File
- ✧ 8 Buttons type: F2 Program→F8 File Manager→F1
New File

- Function

- ✧ Open a new file, and that file will be set as the current edit file.

- Operation Method

- ✧ Press 「New File」 function key, a dialog box will appear, enter the new file name and press **【ENTER】**.

- Note

- ✧ Default format of file name does not have file extension. *.NC is valid file extension incase user wants to creat new file with file extension.
- ✧ The file name cannot be longer than 32 characters(including file extension)

1.4.4.2 Copy File

- Path

- ✧ 5 Buttons type: F2 Program→F4 File Manager→F2
Copy File
- ✧ 8 Buttons type: F2 Program→F8 File Manager→F2
Copy File

- Function

- ✧ Copy the file that remarked by cursor.

- Operation Method

- ✧ Use 【↑】 【↓】 to move the cursor to the file wants to copy.
- ✧ Press 「Copy File」 key.
- ✧ A dialog box will appear, enter the new file name.

- Note

- ✧ Default format of file name does not have file extension. *.NC is valid file extension incase user wants to creat new file with file extension.
- ✧ The file name cannot be longer than 32 characters(including file extension)

1.4.4.3 Delete File

- Path

- ✧ 5 Buttons type:F2 Program→F4 File Manager→F3
Delete File
- ✧ 8 Buttons type:F2 Program→F8 File Manager→F3
Delete File

- Function

- ✧ Delete the file remarked by cursor.

- Operation Method

- ✧ Press F3「Delete File」, selection box will be shown in front of the NC file within the「File Manager」minitor page. Use 【↑】 【↓】 to select the delete file.

- Sub-function Key

- ✧ Select: Select file, can select more than one file and also can cancel the selection of one file.
- ✧ Select All: Select all file.
- ✧ Cancel Select: Cancel all of the selected files.
- ✧ Delete File: Delete all of the selected files.
- ✧ Delete All: Delete all file within data storage device.

- Note

- ✧ Current Programming and machining file cannot be deleted.

1.4.4.4 File Transfer

- Path

- ✧ 5 Buttons type: F2 Program→F4 File Manager→F4 File Transfer
- ✧ 8 Buttons type: F2 Program→F8 File Manager→F4 File Transfer

- Function

- ✧ Transmit data between controller and external storage device.

1.5.2.4.1 File Import

- Path

- ✧ 5 Buttons type: F2 Program→F4 File Manager→F4 File Transfer→F1 File Import
- ✧ 8 Buttons type: F2 Program→F8 File Manager→F4 File Transfer→F1 File Import

- Function

- ✧ Import external file into controller

- Screen Explanation

- ✧ The upper block is the external devices with the following choices.
 - ◆ USBDisk
 - ◆ DiskA
 - ◆ Network
 - ◆ USBDisk2
- ✧ Left column are data stored in the external device.
- ✧ Right column are current data stored in the controller.

- Sub-function Explanation

- ✧ Copy: Copy the remarked file from the external device to the controller.
- ✧ Select: Select file, can select more than one file and also can cancel the selection of one file.
- ✧ Select All: Select all file.
- ✧ Cancel Select: Cancel all of the selected files.
- ✧ Device Change: Change external device.

- Operation Method

- ✧ Press F1 「File Import」, a dialog box will appear.
- ✧ Default external device is USBDisk.
- ✧ Press F5 「Device Change」 to switch between external devices, switch the cursor to the desire device and press 【Enter】, then the left column data structure will change, according to the selected device .
- ✧ Use 【↑】 【↓】 to select file.
- ✧ Move the cursor to the import file and press F2 「Select」 or 【Space】 to remark file.
- ✧ After remarked all of the import file, press F1 「Copy」 then all of the remarked file will import into controller.

1.5.2.4.1 File Export

- Path

- ✧ 5 Buttons type: F2 Program→F4 File Manager→F4 File Transfer→F2 File Export
- ✧ 8 Buttons type: F2 Program→F8 File Manager→F4 File Transfer→F2 File Export

- Function

- ✧ Export file in controller to external device.

- Function Page Explanation

- ✧ The upper block is the external devices with the following choice.

- ◆ USBDisk
- ◆ DiskA
- ◆ Network
- ◆ USBDisk2

- ✧ Left column are data storage from controller.
- ✧ Right column are current data storage in external device.

- Sub-function Explanation

- ✧ Copy: Copy the remarked file from the external device to the controller.
- ✧ Select: Select file, can select more than one file and also can cancel the selection of one file.
- ✧ Select All: Select all file.
- ✧ Cancel Select: Cancel all of the selected files.
- ✧ Device Change: Change external device.

- Operation Method

- ✧ Press 「File Export」, a dialog box will appear.
- ✧ Default external device is USBDisk.
- ✧ Press F5「Device Change」, to switch between external devices, move the cursor to the desire device and press 【Enter】, then the below left column data structure will change, according to the selected device .
- ✧ Use 【↑】 【↓】 to select file.
- ✧ Move the cursor to the export file and press F2 「Select」 or 【Space】 to remark file.
- ✧ After remarked all of the export file, press F1 「Copy」 then all of the remarked file will export from controller to external device.

1.4.4.5 Execute

- Path

- ✧ 5 Buttons type: F2 Program→F4 File Manager→F5 Execute
- ✧ 8 Buttons type: F2 Program→F8 File Manager→F5 Execute

- Function

- ✧ This function can assign the current cursor located program as the executive program and also change the screen to the 「monitor」 page.

- Operation Method

- ✧ Use 【↑】 【↓】 to select file, and then press 「Execute」 the selected file executed.
- ✧ The screen will change to the 「monitor」 page.

- Note

- ✧ This function will be disable when machining.

1.4.5 Simulation

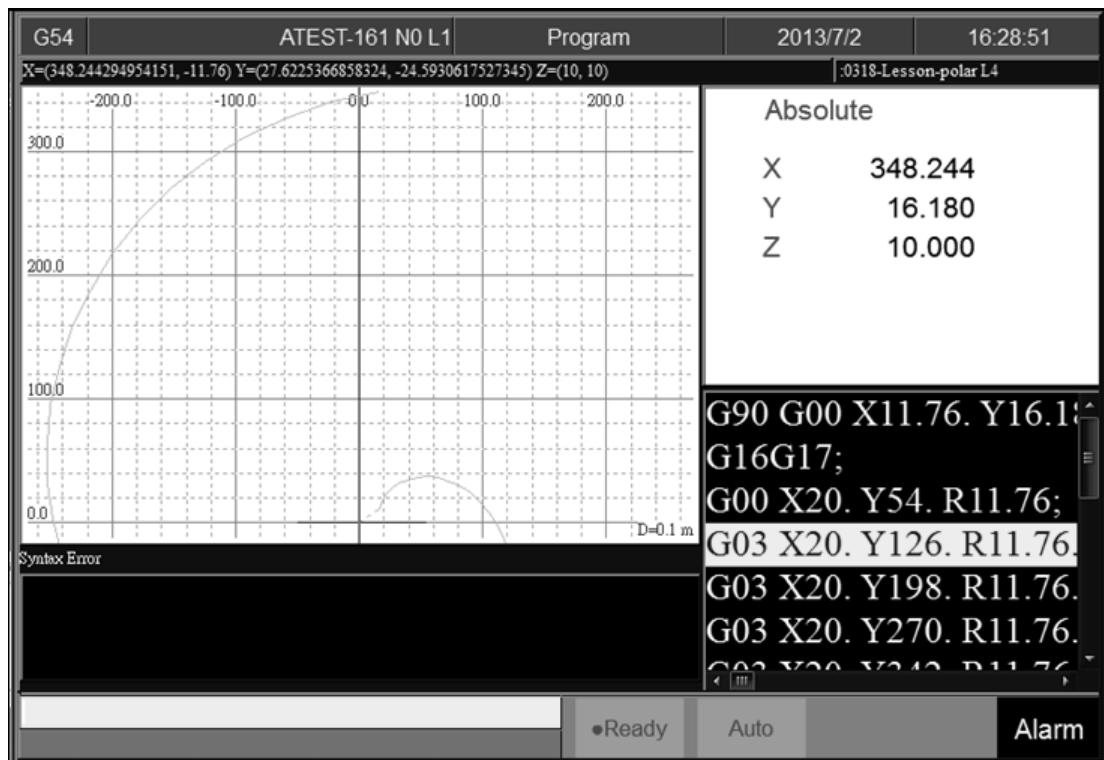

- Path

- ✧ 5 buttons type: F2 Program→F5 Simulation
- ✧ 8 buttons type: F2 Program→F7Simulation

- Function

- ✧ This function can simulate and predict machining path for machining program.
- ✧ Debug ability.
- ✧ Default display range is the largest limit dimension defined by machining program.
- ✧ Relative simulate function can be modified by 「simulate Setting」.

1.4.5.1 Step

- Path

- ✧ 5 Buttons type: F2 Program→F5 Simulation→F1
Step
- ✧ 8 Buttons type: F2 Program→F7 Simulation→F1
Step

- Function

- ✧ Simulate the each single block of machining program.
- ✧ Monitor the coordinate change after single block is executed.

1.4.5.2 Continue

- Path

- ✧ 5 Buttons type: F2 Program→F5 Simulation→F2
Continue
- ✧ 8 Buttons type: F2 Program→F7 Simulation→F2
Continue

- Function

- ✧ Kernel will scan all of the program and then do the simulation.

1.4.5.3 Zoom

- Path

- ✧ 5 Buttons type: F2 Program→F5 Simulation→F3
Zoom
- ✧ 8 Buttons type: F2 Program→F7 Simulation→F3
Zoom

- Function

✧ Zoom out/in the simulation result

● Operation Method

✧ Press F3 「Zoom」, there will be a block shown up.

Using 【↑】 【↓】 【←】 【→】 can move the block to up, down, left and right.

✧ Use 【Page Up】 【Page Down】 to zoom in/out the area within the block.

✧ After the area is selected, press 【ENTER】 to check the result.

1.4.5.4 Graph Reset

- Path

- ✧ 5 buttons type: F2 Program→F5 Simulation→F4 Graph Reset
- ✧ 8 buttons type: F2 Program→F7 Simulation→F4 Graph Reset

- Function

- ✧ According the program reset the simulation result to the normal condition.

1.4.5.5 Simu. Setting

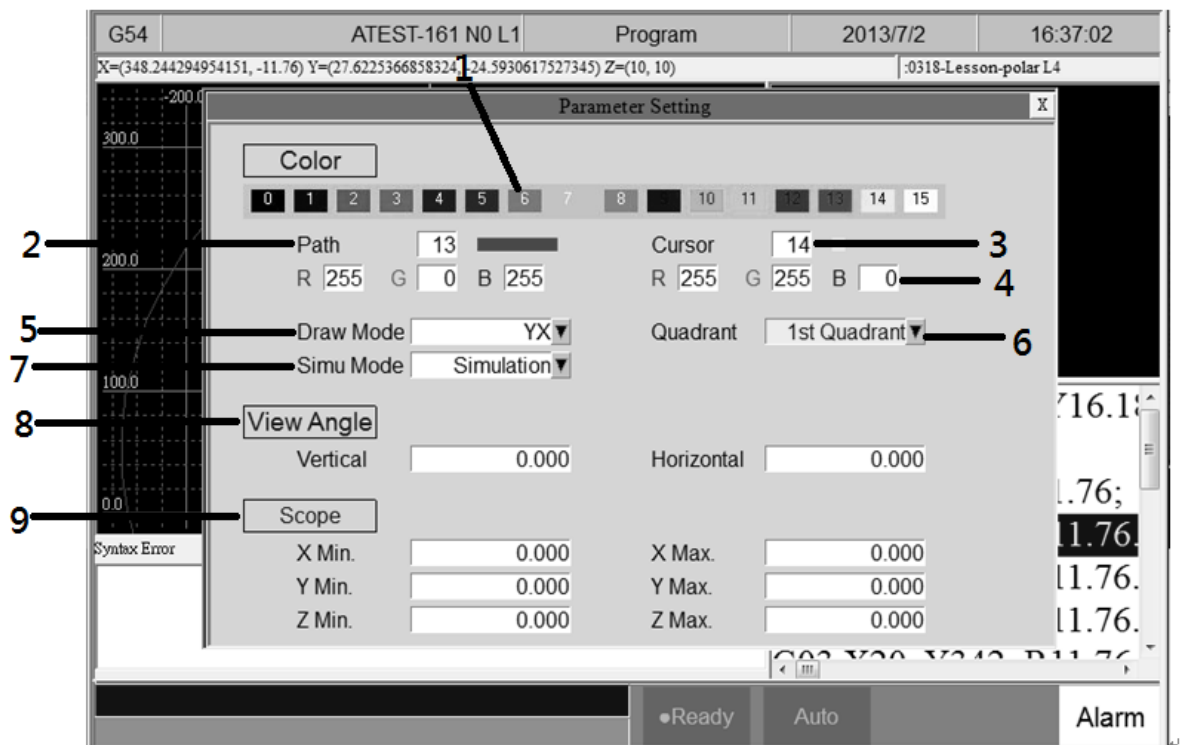

- Path

- ✧ 5 buttons type: F2 Program→F5 Simulation→F5 Simu. Setting
- ✧ 8 buttons type: F2 Program→F7 Simulation→F5 Simu. Setting

- Function

- ✧ Setting the relative simulation item.

- Simulation parameter

- 1.5.2.4.1 Color

- ◆ Provide 0~15 selections, total 16 different kind of color.

- Path Color

- ◆ Simulation cutting path color.
 - ◆ Provide 0~15 selections, total 16 different kind of color.

- Cursor Color

- ◆ Color of cursor point
 - ◆ Provide 0~15 selections, total 16 different kind of color.

- RGB Value

- ◆ Except the provided 16 different kind of color, user can define the color by theirself.

Draw Mode

- ◆ User can define the profile simulate plane.

■Plane can be defined as below.

- XYZ
- XY
- YZ
- ZX
- YX
- ZY
- XZ
-

Setting quadrant

■User can define the profile simulate plane is on which quadrant.

■Quadrant can define are as below.

- ◆ First
- ◆ Second
- ◆ Thrid
- ◆ Fourth

Simulate Mode

- ◆ Setting profile simulate method.
- Simulation
 - ◆ When user change to the 『Monitor』 page, simulation will be displayed automatically.
 - ◆ Controller will simulate machining program after completing scan program. User does not need to define the simulate boundary.
- Direct Draw
 - ◆ When user change to the 『Monitor』 page, cursor will show up but simulation will not execute automatically.
 - ◆ User need to define the simulation scope first.
 - ◆ When the machining is started, cursor will simulate machining path according to single block.
- Not Simulation
 - ◆ Close the simulation function.

View Angle Setting

- Under XYZ draw mode, by setting this parameter, simulation will become 3D simulation.
- View angle can define are as below.
 - ◆ Vertical
 - ◆ Horizontal

Scope

- Scope can define are as below.

■ Minimum

- ◆ X-Axis
- ◆ Y-Axis
- ◆ Z-Axis

■ Maximum

- ◆ X-Axis
- ◆ Y-Axis
- ◆ Z-Axis

1.4.6 Can Cycle

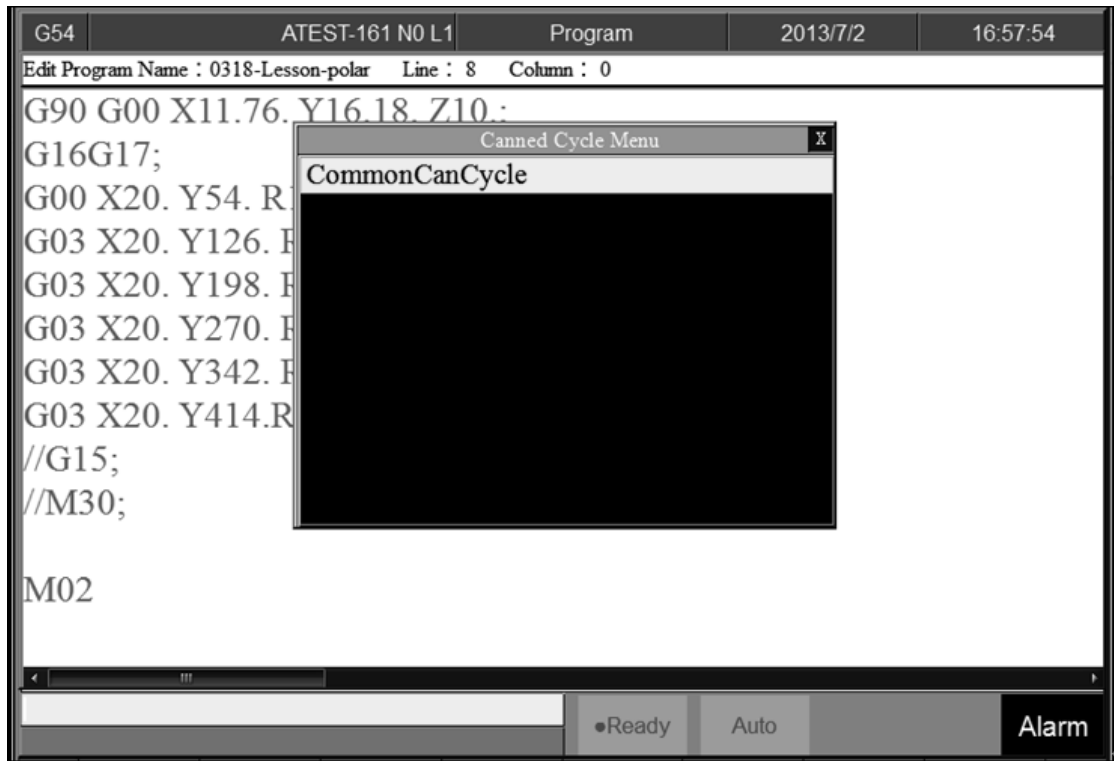

- Path

- ✧ 5 Buttons type: F2 Program→Next→F1 Can Cycle
- ✧ 8 Buttons type: F2 Program→F4Can Cycle

- Function

- ✧ Because Syntec system provides many kind of G code with different function. When editing the program, this function can help user easy to edit G code.

1.4.6.1 Insert Cycle

- Path

- ✧ 5 buttons type: F2 Program→Next→F1 Can Cycle→F1 Insert Cycle
- ✧ 8 buttons type: F2 Program→F4 Can Cycle→F1 Insert Cycle

- Operation Method

- ✧ Move the cursor to the insert location and press 「Insert Cycle」, follow the instruction and insert the required parameters .
- ✧ Press 「OK」, the desire G code will insert into the next line of the current cursor.

1.4.6.2 Edit Cycle

- Path

- ✧ 5 buttons type: F2 Program→Next→F1 Can Cycle→F2 Edit Cycle
- ✧ 8 buttons type: F2 Program→F4 Can Cycle→F2 Edit Cycle

- Function

- ✧ Edit the cycle at current cursor.

- Operation Method

- ✧ Move the cursor to the intend modify location, press 「Edit Cycle」, a modify page will show up. Modify the content and press 「OK」, the content of the current cursor will change.

1.4.7 Block Copy

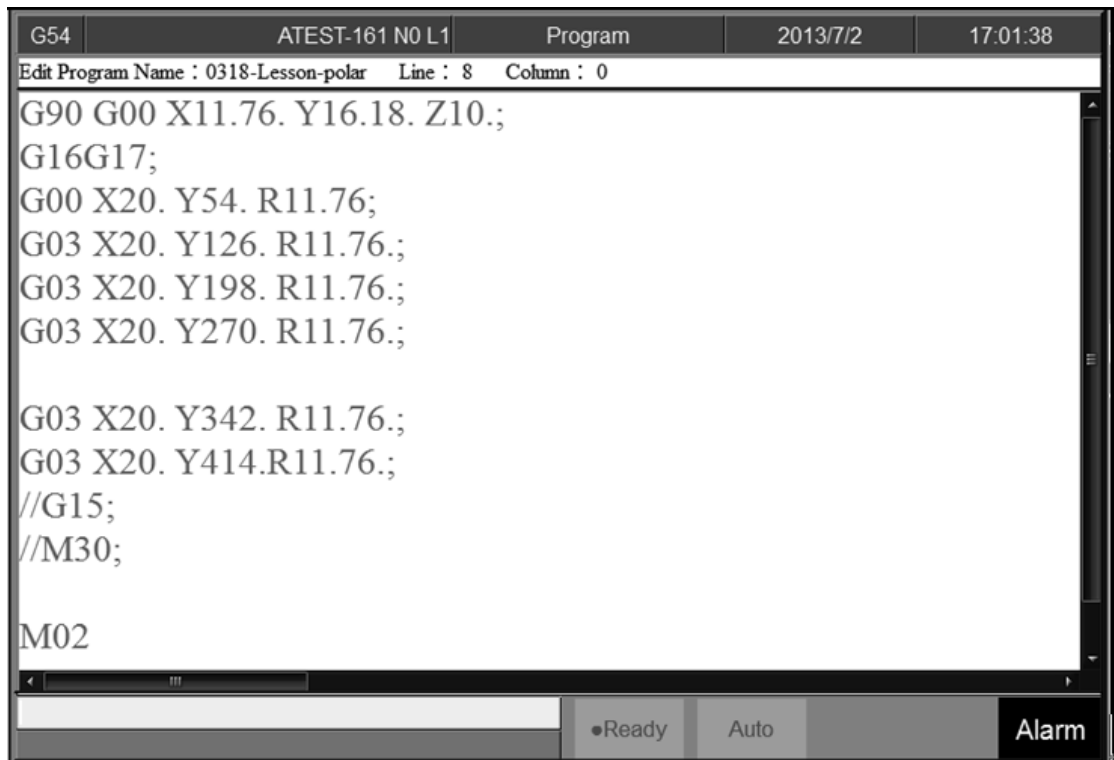

- Path

- ✧ 5 buttons type: F2 Program→Next→F2 Block Copy
- ✧ 8 Buttons type: F2 program→F5 Block Copy

- Function

- ✧ Provide copy, cut, paste for more than one single block

1.4.7.1 Start Line

- Path

- ✧ 5 Buttons: F2 Program→Next→F2 Block Copy→F1 Start Line
- ✧ 8 Buttons: F2 Program→F5Block Copy→F1 Start Line

- Function

- ✧ Select the beginning block.

1.4.7.2 End Line

- Path

- ✧ 5 Buttons: F2 Program→Next→F2 Block Copy→F2 End Line
- ✧ 8 Buttons: F2 Program→F5Block Copy→F2 End Line

- Function

- ✧ Select the finishing block.

1.4.7.3 Block Cut

- Path

- ✧ 5 Buttons: F2 Program→Next→F2 Block Copy→F3 Block Cut
- ✧ 8 Buttons: F2 Program→F5Block Copy→F3 Block Cut

- Function

- ✧ Cut the block that had been selected.

1.4.7.4 Block Copy

- Path

- ✧ 5 Buttons: F2 Program→Next→F2 Block Copy→F4 Block Copy
- ✧ 8 Buttons: F2 Program→F5Block Copy→F4 Block Copy

- Function

- ✧ Copy the block that had been selected.

1.4.7.5 Block Paste

- Path

- ✧ 5 Buttons: F2 Program→Next→F2 Block Copy→F5 Block Paste
- ✧ 8 Buttons: F2 Program→F5Block Copy→ F5 Block Paste

- Function

- ✧ Paste the block that had been 「Block Cut」and「Block Copy」.

● Operation Method

- ✧ Move the cursor to the desire block and press 「 Start Line, function key 「 End Line 」 will be enable.
- ✧ Use the key on panel【 ↑ 】【 ↓ 】【 Page Up 】【 Page Down 】 to select the block, the block selected will be highlight.
- ✧ Confirm the block that had been selected and press 「 End Line 」 .
 - Function key 「 End Line 」 disable.
 - Function key 「 Block Copy 」 enable.
 - Function key 「 Block Cut 」 enable.
 - If 「 Block Cut 」 being use, the whole block that had been highlight will be cut off.
 - Function key 「 Block Copy 」 / 「 Block Cut 」 disable.
 - Function key 「 Block Paste 」 enable.
- ✧ Move the cursor to the desire location and press 「 Block Paste 」 , the content that had been cut or copy will paste at the cursor location.
- ✧ If 「 Block Copy 」 is used, the selected blocks will not be disappeared.

● Note

- ✧ If 「 Block Cut 」 is used, however if 「 Block Paste 」 is not executed, the selected blocks will be disappeared.

- ✧ 「Block Cut」 can paste only one time and 「Block Copy」 can paste many time.

1.4.8 Teach

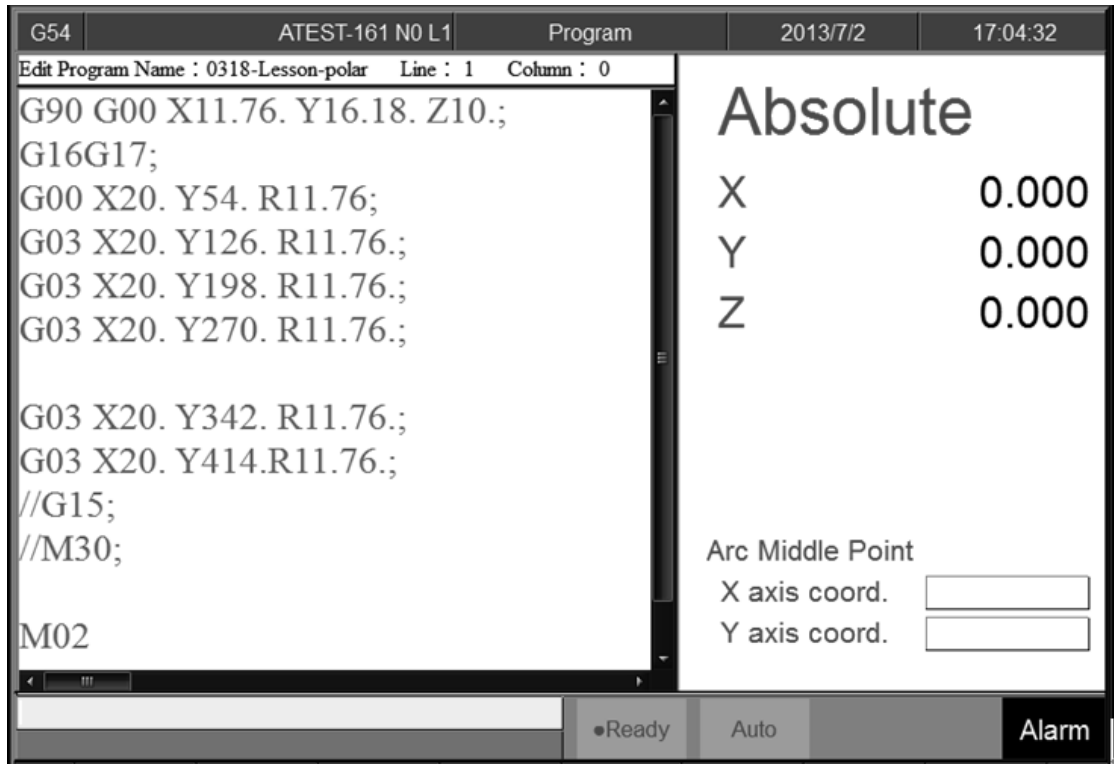

● Path

- ✧ 5 Buttons type: F2 Program→Next→F3 Teach
- ✧ 8 Buttons type: F2 Program→F6 Teach

● Function

- ✧ Use function 『MPG』/『JOG』/『INJOG』, move the machine to destination and use 『Teach』 function, to teach the current absolute coordinate value to the NC program.
- ✧ Omit the manual input problem.

1.4.8.1 Rapid Teach

- Path

- ✧ 5 Buttons type: F2 Program→Next→F3 Teach→F1 Rapid Teach
- ✧ 8 Buttons type: F2 Program→F6 Teach→F1 Rapid Teach

- Function

- ✧ Add the current absolute coordinate as the value of 「G00 Rapid Traverse」 function in current program.

1.4.8.2 Line Cut Teach

- Path

- ✧ 5 Buttons type:F2 Program→Next→F3 Teach→F2 Line Cut Teach
- ✧ 8 Buttons type:F2 Program→Next→F6Teach→F2 Line Cut Teach

- Function

- ✧ Add the current absolute coordinate as the value of 「G01 Linear Cutting」 function in current program.

1.4.8.3 Arc Cut Teach

- Path

- ✧ 5buttons key: F2 Program→Next→F3 Teach→F3 Arc Cut Teach
- ✧ 8 buttons key: F2 Program→F6 Teach→F3 Arc Cut Teach

- Function

- ✧ Add the current absolute coordinate as the machining value of 「G02/G03 Circular Cutting」 function in current program.

- Operation Method

- ✧ Move the machine table to the arc center and press 「Arc Cut Teach」, current absolute coordinate will be defined as the arc center.
- ✧ Move the machine table to the ending of the arc and press 「Arc Cut Teach」, current absolute coordinate will be defined as the ending of the arc. Controller will automatically calculate the relation between middle and end point and determine whether to use G02 or G03. The calculation result will be added in current cursor location of program.

1.4.8.4 Cancel Arc Middle

- Path

- ✧ 5 Buttons type: F2 Program→Next→F3 Teach→F4
Cancel Arc Middle
- ✧ 8 Buttons type: F2 Program→F6 Teach→F4 Cancel
Arc Middle

- Function

- ✧ Clear the arc middle point that had been set.
- ✧ If the arc middle were not set, this function will be
disable.

1.4.8.5 Point Teach

- Path

- ✧ 5 buttons type: F2 Program→Next→F3 Teach→F5
Point Teach
- ✧ 8 buttons type: F2 Program→F6 Teach→F5 Point
Teach

- Function

- ✧ Move the worktable to the arc center and press 「 Point
Teach 」 , current absolute coordinate will be added in
current cursor location of program.

1.5 Offset/Setting

G54	TEST N-1 L1	Offset/Setting	2013/7/2	19:39:48
Input Mode (A)bsolute (I)ncrement			Machine	
Absolute			X 100.000	
	XWear	YWear	ZWear	Z 100.000
1	0.000	0.000	0.000	Y 100.000
2	0.000	0.000	0.000	<hr/>
3	0.000	0.000	0.000	Absolute
4	0.000	0.000	0.000	X -20.000
5	0.000	0.000	0.000	Z 100.000
6	0.000	0.000	0.000	Y 100.000
7	0.000	0.000	0.000	<hr/>
8	0.000	0.000	0.000	Relative
			X	100.000
			Z	100.000
			Y	100.000
INC: +/-1.000			●Ready	Not Select
			Alarm	

- Path

- ✧ F3 Offset/Setting

- Function

- ✧ Under this function group, user can do the offset/Setting.

- ✧ Use the group function key **【Offset/Setting】** can switch to the current page quickly.

1.5.1 Tool Wear Set

G54	TEST N-1 L1	Offset/Setting	2013/7/2	19:39:48
Input Mode (A)bsolute (I)ncrement			Machine	
Absolute			X	100.000
	XWear	YWear	Z	100.000
1	0.000	0.000	Y	100.000
2	0.000	0.000	Absolute	
3	0.000	0.000	X	-20.000
4	0.000	0.000	Z	100.000
5	0.000	0.000	Y	100.000
6	0.000	0.000	Relative	
7	0.000	0.000	X	100.000
8	0.000	0.000	Z	100.000
			Y	100.000
INC: +/-1.000			●Ready	Not Select
			Alarm	

● Path

✧ F3 Offset/Setting→F1 Tool Wear Set

● Function

✧ Set the wear of tool.

✧ Actual tool length=Tool length+Tool wear

● Function of parameter

✧ Wear: Tiny modification of tool length.

● Note

✧ When the tool length had been set, related tool wear will become zero.

✧ If the tool wear is set under the machining condition, new tool wear setting will be effective in next compensation time.

1.5.2 Tool Length Set

G54	TEST N-1 L1	Offset/Setting	2013/7/2	19:43:43
Input Mode (A)bsolute (I)ncrement			Machine	
Absolute			X 100.000	
	XLength	YLength	Z	100.000
1	0.000	0.000	Y	100.000
2	0.000	0.000	Absolute	
3	0.000	0.000	X	-20.000
4	0.000	0.000	Z	100.000
5	0.000	0.000	Y	100.000
6	0.000	0.000	Relative	
7	0.000	0.000	X	100.000
8	0.000	0.000	Z	100.000
			Y	100.000
			●Ready	Not Select
			Alarm	

- Path

- ✧ F3 Offset/Setting→F2 Tool Length Set

- Function

- ✧ Set the length of tool.

- ✧ Actual tool length=Tool length+Tool wear

- Function of parameter

- ✧ Tool length: G43/G44 tool length compensation setting.

- Note

- ✧ When the tool length had been set, related tool wear will become zero.

- ✧ Setting is prohibited in machining condition.

1.5.3 Tool Nose Set

G54	TEST N-1 L1	Offset/Setting	2013/7/2	19:46:48
Input Mode (A)bsolute (I)ncrement			Machine	
<input type="text" value="Absolute"/>			X 100.000	
Radius R.Wear Nose			Z 100.000	
1	0.000	0.000	0	Y 100.000
2	0.000	0.000	0	Absolute
3	0.000	0.000	0	X -20.000
4	0.000	0.000	0	Z 100.000
5	0.000	0.000	0	Y 100.000
6	0.000	0.000	0	Relative
7	0.000	0.000	0	X 100.000
8	0.000	0.000	0	Z 100.000
				Y 100.000
			●Ready	Not Select
			Alarm	

● Path

✧ F3 Offset/Setting→F3 Tool Nose Set

● Function

✧ Set the top position of Tool .

✧ Real Tool Nose= Tool Nose Radius+Tool Nose Radius wear

● Function of parameter

✧ Tool Nose Radius: G41/G42 Tool Nose Radius compensation (not diameter).

✧ Tool Nose Radius Wear : G41/G42 Tiny modification of Tool Nose Radius.

✧ Tool Nose direction: Set the machining direction of Tool Nose.

SYNTEC

- ✧ Syntec provide total 8 different kind of Tool Nose direction option, see 《Syntec Lathe Programming Manual—G41/G42》 ◦

- Note

- ✧ Setting is prohibited in machining condition.

1.5.4 User Parameter Setting

G54	ATEST-161 N0 L1		Offset/Setting	2013/7/2	17:42:56
Index	Item		Value(Not Login)		
4001	Tapping mode(0:peck tapping,1:high-speed)		0		
4002	Drilling cycle retrace amount(LIU)		5000		
4004	Tapping cycle retrace amount(LIU)		0		
4006	Tapping cycle retrace speed(%)		100		
4010	Facing cycle X/Y plane milling stepover percent		50		
4020	OSS direction of boring cyle(0:X+,1:X-,2:Y+,3:Y-,4:Z+,5:Z-)		0		
0~1			•Ready	Auto	Alarm

- Path
 - ◇ F3 Offset/Setting→F4 User Parameter Setting
- Function
 - ◇ Syntec controller provided user to set the related machining parameter.
- Function of parameter
 - ◇ Detail explanation can be seen in 「 Lathe Parameter Manual 」 .

1.5.5 Working Shift

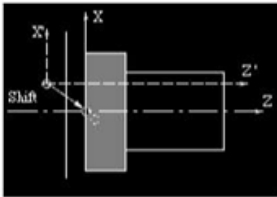
G54	TEST N-1 L1	Offset/Setting	2013/7/2	19:47:32	
Input Mode: Incremental			Absolute		
Shift Amount			X	-20.000	
X	0.000	Z	100.000	Y	100.000
Z	0.000	Machine			
Incremental		X	100.000		
1. Move cursor to X or Z field		Z	100.000		
2. Input increment value		Y	100.000		
Absolute					
1. Input X*** to set X absolute position					
2. Input Z*** to set Z absolute position					
Can't set in busying, execute G92 will change shift amount!					
		●Ready	Not Select	Alarm	

- Path

- ✧ F3 Offset/Setting→F5 Working Shift

- Function

- ✧ Set G92 coordinate offset.

- Operation Method

- Absolute Input

- ✧ Enter **【X】** / **【Z】** and then Enter value, press

- 【ENTER】** .

- Increment Input

- ✧ Move the cursor to the coordinate that want to setting.

- ✧ Enter value and press **【ENTER】** .

1.5.6 Work Piece Cord.

G54		TEST N-1 L1		Offset/Setting		2013/7/2		19:48:53	
External Shift		G54P1(G54)		G54P2(G55)		Machine			
X	0.000	X	120.000	X	0.000	X	100.000		
Y	0.000	Y	0.000	Y	0.000	Z	100.000		
Z	0.000	Z	0.000	Z	0.000	Y	100.000		
G54P3(G56)		G54P4(G57)		G54P5(G58)		Relative			
X	0.000	X	0.000	X	0.000	X	100.000		
Y	0.000	Y	0.000	Y	0.000	Z	100.000		
Z	0.000	Z	0.000	Z	0.000	Y	100.000		
						Aux. Coord			
						X	0.000		
						Y	0.000		
						Z	0.000		
						●Ready	Not Select		Alarm

● Path

- ✧ 5 Buttons key: F3 Offset/Setting→Next→F1 Work Piece Cord.
- ✧ 8 Buttons key: F3 Offset/Setting→F6Work Piece Cord.

● Function

- ✧ This function key switch the screen to the 『Work Piece Cord』 setting page.
- ✧ If user do not define the coordinate system as G54~G59.10, the default system is G54.
- ✧ 『External Shift』 : All setting of 『External Shift』 will be effective in G54~G59.10.

● Operation Method

SYNTEC

- ✧ Use the key on panel 【↑】 【↓】 to move the cursor.
- ✧ Use 【Page Up】 【Page Down】 to switch page.

- Note

- ✧ After Setting 『Work Piece Cord』 , Tool Length compensation need to re-setting again.

1.5.6.1 Mach. Coord. Teach

- Path

- ✧ 5 Buttons type: F3 Offset/Setting→Next→F1 Work Piece Cord.→F1Mach. Coord. teach
- ✧ 8 Buttons type: F3 Offset/Setting→F6 Work Piece Cord.→F1 Mach. Coord. teach

- Function

- ✧ By the absolute input method, set the current cursor located work piece coordinate value as the mechanical coordinate value.

- Operation Method

- ✧ Move the worktable to the destination.
- ✧ Move the cursor to the relate work piece coordinate and press 「 Mach. Coord. teach 」
- ✧ Current cursor located work piece coordinate will be replaced by the mechanical coordinate.

- Example

- ✧ Current mechanical coordinate of X axis is 5.000
- ✧ Current workpiece coordinate G54 of X axis is 0.000
- ✧ Move the cursor to G54 X axis.
- ✧ Press 「 Mach. Coord. teach 」,the coordinate of G54 X axis become 5.000

1.5.6.2 Mach. Coord. Inc. Teach

- Path

- ✧ 5 buttons type:F3 Offset/Setting→Next→F1 Work Piece Cord.→F2 Mach. Coord Inc. Teach
- ✧ 8 buttons type:F3 Offset/Setting→F6Work Piece Cord.→F2 Mach. Coord Inc. Teach

- Function

- ✧ Current cursor located work piece coordinate will be replaced by the 「Mechanical coordinate」 plus 「Mach. Coord Inc. Teach」 value.

- Operation Method

- ✧ Move the worktable to the destination.
- ✧ Move the cursor to the relate work piece coordinate, key in teach value. And then press 「Mach. Coord Inc. Teach」
- ✧ Current cursor located work piece coordinate will be replaced by the mechanical coordinate plus Increment value.

- Example

- ✧ Current mechanical coordinate of X axis is 5.000
- ✧ Current workpiece coordinate G54 of X axis is 0.000
- ✧ Move the cursor to G54 X axis.
- ✧ Key in 10.

- ✧ Press 「 Mach. Coord Inc. Teach 」 ,the coordinate of G54 X axis become 15.000

1.5.6.3 **Inc. Input**

- path

- ✧ 5 buttons type: F3 Offset/Setting→Next→F1 Work Piece Cord.→F3 Inc. Input
- ✧ 8 buttons type: F3 Offset/Setting→F6 Work Piece Cord.→F3 Inc. Input

- Function

- ✧ Current cursor located work piece coordinate will be replaced by current cursor value plus teach value.

- Operation Method

- ✧ Move the worktable to the destination.
- ✧ Move the cursor to the relate work piece coordinate, key in teach value. And then press 「 Inc. Input 」 function key.
- ✧ Current cursor located work piece coordinate will be replaced by the current coordinate value plus teach value.

- Example

- ✧ Current G54 X axis value is 5.000
- ✧ Move the cursor to G54 X axis.
- ✧ Key in 10.

- ✧ Press 「 Inc. Input 」 function key ,the coordinate of G54 X axis become 15.000

1.6 Monitor

G54		TEST N0 L1		Monitor		2013/7/2		20:05:46	
Absolute		Dist. To Go		G Code G1		Run Time 0 : 0 : 0		Accum 0 : 0	
X	-20.000	X	0.000	G18 G90 G95		G00 Over 100 %			
Z	100.000	Z	0.000	G71 G40 G49		G01 Over 100 %			
Y	100.000	Y	0.000			Spd Over 100 %			
Feedrate 0.0mm/min				T 0000		TotalAcumPar 0			
Spindle 1000RPM				Start Block No. 1		Part Count 0			
G00 X100.000 Y100.000 Z100.000									
G0X100.Y100.Z100.C100.									
G00 X0.000 Z100.000;									
G04X5.S1000									
G00 X100.000									
						Ready		Not Select	
								Alarm	

- Path:

- ✧ F4 Monitor

- Description

- ✧ This function key provides all necessary required information in machining process.

- Menu description

- 1. Machine Monitor Area**

- ◆ This area displays current machining data
- ◆ Absolute coordinate
- ◆ Dist. To go
- ◆ Feedrate
- ◆ Spindle speed,

- 2. Program Monitor Area**

- ◆ Display current machining program
- ◆ The yellow single block indicates the current machined one

1.6.1 Monitor Area of Machining Information

G54		TEST N0 L1		Monitor 1		2013/7/2		20:05:46	
Absolute		Dist. To Go		G Code G1		Run Time 0 : 0 : 0		Accum 0 : 0	
X	-20.000	X	0.000	G18 G90 G95		G00 Over 100 %			
Z	100.000	Z	0.000	G71 G40 G49		G01 Over 100 %			
Y	100.000	Y	0.000			Spd Over 100 %			
Feedrate 0.0 mm/min		T 0000		TotalAcumPar 0					
Spindle 1000RPM		Start Block No. 1		Part Count 0					
G00 X100.000 Y100.000 Z100.000									
G0X100.Y100.Z100.C100.									
G00 X0.000 Z100.000;									
G04X5.S1000									
G00 X100.000									
				Ready		Not Select		Alarm	

● Description

✧ This area and machining setting are overlapped, users can press "F4-parameter set" to switch between those two displays

1. G-code status

◆ Display the current G-code that system are running.

2. Run time

◆ Display machining time of one workpiece.

◆ When machining program is started, it will start to count.

3. Accum run time

◆ Display the total machining time

4. Override

- ◆ G00 Override
- ◆ G01 Override
- ◆ Spindle Override

5. Total AcumPar

- ◆ Total workpieces that CNC machined
- ◆ The system can not automatically reset this value to zero
- ◆ If users want to reset manually, please switch to the "machining setting area" and set Total AcumPar equal to 0

6. Part count

- ◆ It will is reset to 0 when machining other machining program
- ◆ Display the No. workpieces machined currently

7. Start block

- ◆ Users can set the starting single block in machining program.

● Operation:

- ◆ n: Specify the starting single block is the nth row in program. (Ex: 20)
- ◆ L+ n: Specify the starting single block is the nth row in program. (Ex: L20)

- ◆ N+ n: Search the single block that has N+n sign and specify that single block as the starting line. (Ex: N3)
- ◆ T+ n: Search the single block that has T+n sign and specify that single block as the starting line.. (Ex: T01)
- ◆ If users specify the number of single block exceeding the maximum row number of program, system will set the last single block as default value

8. Machining tool information

- ◆ T
- ◆ 4 codes displayed.
- ◆ First 2 codes are the tool number currently machining
- ◆ 2 subsequent codes specify the tool number executing compensation.

1.6.2 Display Area of Machining Setting

- Description

- ✧ This area and machining information are overlapped, users can press "F4-parameter set" to exchange between those two display.

- Display description

- Interrupt Line No.

- ✧ Display the line number interrupted at last time (L)

- Interrupt Colum No.

- ✧ Display the Colum No. interrupted at last time (N)

- Spindle speed

- ✧ Set the speed of spindle
 - ✧ Can be set when system is on busy status. Moreover, it will be activated immediately

- Feedrate

- ✧ Set the speed of the feed. °
 - ✧ Can be set when system is on busy status
 - ✧ This value will be updated after completely excuting current single block

- Total AcumPar

- ✧ Total workpieces that CNC machined
 - ✧ The system can not automatically reset this value to zero

- Part count

- ✧ It will is reset to 0 when machining other machining program

- ✧ Display the No. workpieces machined currently
- ✧ When CNC executes one M code defined by parameter 3804-part count M code, part count would be added 1 automatically and run time will be reseted to 0. When part count is reached, system will change to pause status.

- Required Part

- ✧ Set number of workpieces wants to machine
- ✧ Once the number of required part is reached, an alarm will be issued and system will change to pause status.

1.6.3 Simulation Graph

- Description

- ✧ Display the tool trajectory of current machining program.
- ✧ Related setting, please refer to " Simu. Setting."
- ✧ Use " simulation switch" to change display content

1.6.4 Open File to Edit

- Path:

- ✧ F4 monitor→F1 Open file to edit

- Description

- ✧ Enter and edit the current machining program, also switch to “F2-program” interface

- ✧ Note: once system is on busy status, user cannot edit current machining program

1.6.5 Simulation Switch

- Path:

- ✧ F4 monitor→F2 Simulation switch

- Description

- ✧ Check whether simulation function works properly

- ✧ Only modifying simulation properties when entering simulation setting interface.

1.6.6 MDI Input

- Path:

- ✧ F4 monitor→F3 MDI input

- Description

- ✧ Manual Data Input. Using for simple NC program or testing purpose

- Operation:

- ✧ Select MDI mode

- ✧ MDI function is enabled after finishing to return referent point (HOME)

- ✧ Press F3 -MDI input and type in G or M code.

- ✧ Press F1 (OK) to confirm the input command.
- ✧ The typed-in command line will show on right upper corner of the screen.
- ✧ Press **【CYCLE START】** on the operator panel to execute the single-line command.

- Note:

- ✧ must select MDI mode first

1.6.7 Parameter Set

- Path:

- ✧ F4 monitor→F4 Parameter set

- Description

- ✧ Switching between “machining setting” and “machining information”

1.6.8 Tool Wear Set

- Path:

- ✧ F4 monitor→F5 Tool wear set

- Description

- ✧ Display the tool wear setting interface, user can setting tool wear here.

1.6.9 Work Record

- Path:

- ✧ 5 Buttons type: F4 monitor→ Next→F2 work record
- ✧ 8 Buttons type: F4 monitor→ F7 work record

- Description

- ✧ Check current machining record, can export to external storage devices

1.6.10 Clear Acum Cycle time

- Path:

- ✧ 5 Buttons type: F4 monitor → Next → F3 Clear Acum Cycle time
- ✧ 8 Buttons type: F4 monitor → F8 Clear Acum Cycle time

- Description

- ✧ Clear the accumulative time

1.6.11 Graph Adjust

- Path:

- ✧ 5 Buttons type: F4 monitor → Next → F4 Graph adjust

- ✧ 8 Buttons type: F4 monitor → Next → F1 Graph adjust

- Description

- ✧ Zoom in/out simulation graph

- Operation

- ✧ See “Zoom ” in “simulation”

1.7 Maintain

- Path:

- ✧ F5 Maintain

- Description

- ✧ This function key displays alarm, network setting, fast diagnostic, PLC param setting, system setting

1.7.1 Alarm

G54	TESTN0L1			Alarm	2013/7/2	20:06:11
No.	Module	ID	Issue Time	Content		
				●Ready	Not Select	Alarm

- Path:

- ✧ F5 Maintain→F1 Alarm

- Description

- ✧ Whenever the system or the program stops due to errors, alarm messages will be shown on the screen

1.7.1.1 Pending Alarm

- Path:
 - ✧ F5 Maintain→F1 Alarm→ F1 Pending Alarm
- Description
 - ✧ Display system alarm content at present

1.7.1.2 History Alarm

- Path:
 - ✧ F5-Maintain→F1 Alarm→ F2 History Alarm
- Description
 - ✧ Show all the alarm history of the system.
- Note:
 - ✧ Some alarm is not displayed here, ex: MACRO alarm

1.7.1.3 Save Alarm

- Path:
 - ✧ F5 Maintain→F1 Alarm→ F3 Save alarm
- Description
 - ✧ Save Alarm History to external disk.
 - Default export file name:
 - ✧ Actual alm: actalm.txt.
 - ✧ History: histalm.txt.

1.7.2 Network Setting

G54	TEST N0 L1	Network Setting	2013/7/2	20:12:22
IP Address Parameter				
IP Address Setting	Specify an IP Address ▼			
IP Address	210.20.98.21	Name Server Parameter		
Subnet Mask	255.255.255.0	Primary DNS		
Default Gateway	210.20.98.1	Primary WINS		
Network DiskRemote Host Path				
PC Name	NCYANG	Dir Name	123	
User Name		Password		
Net Status	Code : -1 Unknown Error			
Resource Shared				
Shared Folder Path	DiskA\OpenCNC\NcFiles			
				Alarm

- Path:

- ✧ F5 Maintain→F2 Network setting

- Description

- ✧ Set system network setting

- Related infor.

- ✧ IP address setting

- ✧ Network cable(with HUB), select "Obtain an IP address automatically"

- ✧ Jumper cable(without HUB), select "use the following IP address" and enter IP address(the forth number is different from PC setting) and Subnet mask(same with PC setting)

- IP address

- ✧ Only applied for “use the following IP address” option.
- Subnet mask
 - ✧ Enter the IP address for subnet mask (the same with PC subnet mask).
- PC name
 - ✧ Enter the full computer name
 - ✧ Need to be the same with PC
- Dir name
 - ✧ Enter the sharing folder name (the same name with PC sharing folder)
 - ✧ User name and password
 - ✧ If the shared folder is not set the password, user do not need to enter user name, if yes, please enter the same password.

1.7.2.1 Set Kernel Server

G54	TEST N0 L1	Network Setting	2013/7/2	20:45:58
Kernel Server Setting				
Start server while boot		<input type="checkbox"/>		
TimeOut (milisec)		<input type="text"/>		
<input type="button" value="Ready"/> <input type="button" value="Not Select"/> <input type="button" value="Alarm"/>				

- ✧ Path:
- ✧ F5 Maintain → F2 Network Setting → F5 Set Kernel Server

- Description

- ✧ Setting function related to kernel server
- ✧ Related infor.
- ✧ Start server while boot
- ✧ Setting whether server is started when booting
- ✧ Timeout(Milisec)
- ✧ Set the acceptable time out when connecting to the Kernel server unsuccessfully

1.8.2.1.1 Start Server

- Path:

✧ F5 Maintain → F2 Network setting → F5 Set Kernel
Server → F1 Start Server

● Description

✧ Start server immediately

1.7.3 Fast Diagnostic

G54	TEST NO L1	Fast Diagnostic	2013/7/2	20:13:35
Browser::Tal				
FastSysData1	7067	FastSysData7	99	FastSysData11 -1
FastSysData2	360596	FastSysData12	0	FastSysData22 0
FastSysData3	72119	FastSysData14	5000	FastSysData23 0
FastSysData4	300495	FastSysData13	1000	FastSysData19 0
FastSysData5	2000	FastSysData15	0	FastSysData20 0
FastSysData6	10000	FastSysData16	0	FastSysData21 0
FastSysData10	23	FastSysData17	0	FastSysData24 0
FastSysData8	153358336	FastSysData18	0	FastSysData25 0
FastSysData9	153358336	FastSysData27	0.0.11	FastSysData26 6B
			●Ready	Not Select
				Alarm

● Path:

✧ F5 Maintain → F3 Fast diagnostic

● Description

✧ Display simple diagnostic information of system and axes

1.7.3.1 System Data

G54	TEST NO L1	Fast Diagnostic	2013/7/2	20:13:35
Browser::Tal				
FastSysData1	7067	FastSysData7	99	FastSysData11 -1
FastSysData2	360596	FastSysData12	0	FastSysData22 0
FastSysData3	72119	FastSysData14	5000	FastSysData23 0
FastSysData4	300495	FastSysData13	1000	FastSysData19 0
FastSysData5	2000	FastSysData15	0	FastSysData20 0
FastSysData6	10000	FastSysData16	0	FastSysData21 0
FastSysData10	23	FastSysData17	0	FastSysData24 0
FastSysData8	153358336	FastSysData18	0	FastSysData25 0
FastSysData9	153358336	FastSysData27	0.0.11	FastSysData26 6B
			●Ready	Not Select
				Alarm

- Path:

- ✧ F5 Maintain → F3 Fast diagnostic → F1 System Data

- Description

- ✧ Display simple diagnostic information of system

1.7.3.2 Axes Data

G54	TEST NO L1	Fast Diagnostic	2013/7/2	20:14:27
Browser::Tab				
		X	Y	Z
	FastAxesData1	-20000	100000	100000
	FastAxesData1	100000	100000	100000
	FastAxesData3	100000	100000	100000
	FastAxesData4	100000	100000	100000
	FastAxesData5	0	0	0
	FastAxesData6	0	0	0
	FastAxesData7	5556	5556	5556
	FastAxesData8	0	0	0
	FastAxesData9	0	0	0
	FastAxesData10	0	0	0
	FastAxesData11	0	0	0
	FastAxesData12	0	0	0
	FastAxesData13	0	0	0
		●Ready	Not Select	Alarm

● Path:

✧ F5 Maintain → F3 Fast diagnostic → F2 Axes data

● Description

✧ Display simple diagnostic information of Axes

1.7.4 PLC Param Setting

G54		TEST NO L1	Offset/Setting							2013/7/2				20:14:56				
Index	Item	Value	F	E	D	C	B	A	9	8	7	6	5	4	3	2	1	0
3401	Extension Parameter(R	0x0000	0	0	0	0	0	0	0	0	0	0	0	0	0	0	0	0
3402	Extension Parameter(R	0x0000	0	0	0	0	0	0	0	0	0	0	0	0	0	0	0	0
3403	Extension Parameter(R	0x0000	0	0	0	0	0	0	0	0	0	0	0	0	0	0	0	0
3404	Extension Parameter(R	0x0000	0	0	0	0	0	0	0	0	0	0	0	0	0	0	0	0
3405	Extension Parameter(R	0x0000	0	0	0	0	0	0	0	0	0	0	0	0	0	0	0	0
3406	Extension Parameter(R	0x0000	0	0	0	0	0	0	0	0	0	0	0	0	0	0	0	0
3407	Extension Parameter(R	0x0000	0	0	0	0	0	0	0	0	0	0	0	0	0	0	0	0
3408	Extension Parameter(R	0x0000	0	0	0	0	0	0	0	0	0	0	0	0	0	0	0	0
3409	Extension Parameter(R	0x0000	0	0	0	0	0	0	0	0	0	0	0	0	0	0	0	0
3410	Extension Parameter(R	0x0000	0	0	0	0	0	0	0	0	0	0	0	0	0	0	0	0
3411	Extension Parameter(R	0x0000	0	0	0	0	0	0	0	0	0	0	0	0	0	0	0	0
3412	Extension Parameter(R	0x0000	0	0	0	0	0	0	0	0	0	0	0	0	0	0	0	0
3413	Extension Parameter(R	0x0000	0	0	0	0	0	0	0	0	0	0	0	0	0	0	0	0
3414	Extension Parameter(R	0x0000	0	0	0	0	0	0	0	0	0	0	0	0	0	0	0	0
3415	Extension Parameter(R	0x0000	0	0	0	0	0	0	0	0	0	0	0	0	0	0	0	0
3416	Extension Parameter(R	0x0000	0	0	0	0	0	0	0	0	0	0	0	0	0	0	0	0

Comment Extension Parameter Bit R81.1

0~1 Ready Not Select

- Path:

- ✧ F5 Maintain → F4 PLC param setting

- Description

- ✧ SYNTEC's controller provides R81 ~ R100, totally 20 sets of registers for machinery manufacture use, with 16Bits of each register.

- ✧ Machinery manufacture can use these 20 sets of registers to provide user execute control flag in PLC specific functions.

- Operation

- ✧ Use **【↑】** **【↓】** **【←】** **【→】** to move cursor and

- 【PageUp】** **【PageDown】** to switch to next page

- ✧ Only can enter [0] or [1].

- ✧ Available some bits for comment
- ✧ Corresponding file name for comment:
ParamExt_RBit_(L).xml
- ✧ (L)=COM/CHT/CHS/language

1.7.5 System Setting

G54	TEST NO L1	Offset/Setting	2013/7/2	20:15:32
Operator Mode Setting				
Input/Display Unit(0:mm, 1:inch)			<input type="text" value="0"/>	
System Time Setting				
Date	<input type="text" value="2013/7/2"/>			
Time	<input type="text" value="20/15/32"/>			
Program file font size setting				
Size	<input type="text" value="20"/>			
(0~1)		●Ready	Not Select	Alarm

- Path:

- ✧ F5 Maintain → F5 System setting

- Description

- ✧ This part is used to set system environment

- Operation

- ✧ Use **【↑】** **【↓】** **【←】** **【→】** to move cursor and **【PageUp】** **【PageDown】** to switch to next page

1.7.5.1 Operator Mode Setting

- ✧ Setting system unit
- ✧ 0 : mm
- ✧ 1 : Inch
- ✧ Note: reboot to enable setting

1.7.5.2 System Time Setting

- ✧ Date: input format YYYY/MM/DD
- ✧ YYYY: year
- ✧ MM: month
- ✧ DD: day
- ✧ Time: input format HH/MM/SS
- ✧ HH: hours
- ✧ MM: minute
- ✧ SS: second

1.7.5.3 Program File Font Size Setting

- ✧ Setting display of font size in program
- ✧ Note: reboot to enable setting

1.7.6 Backup System

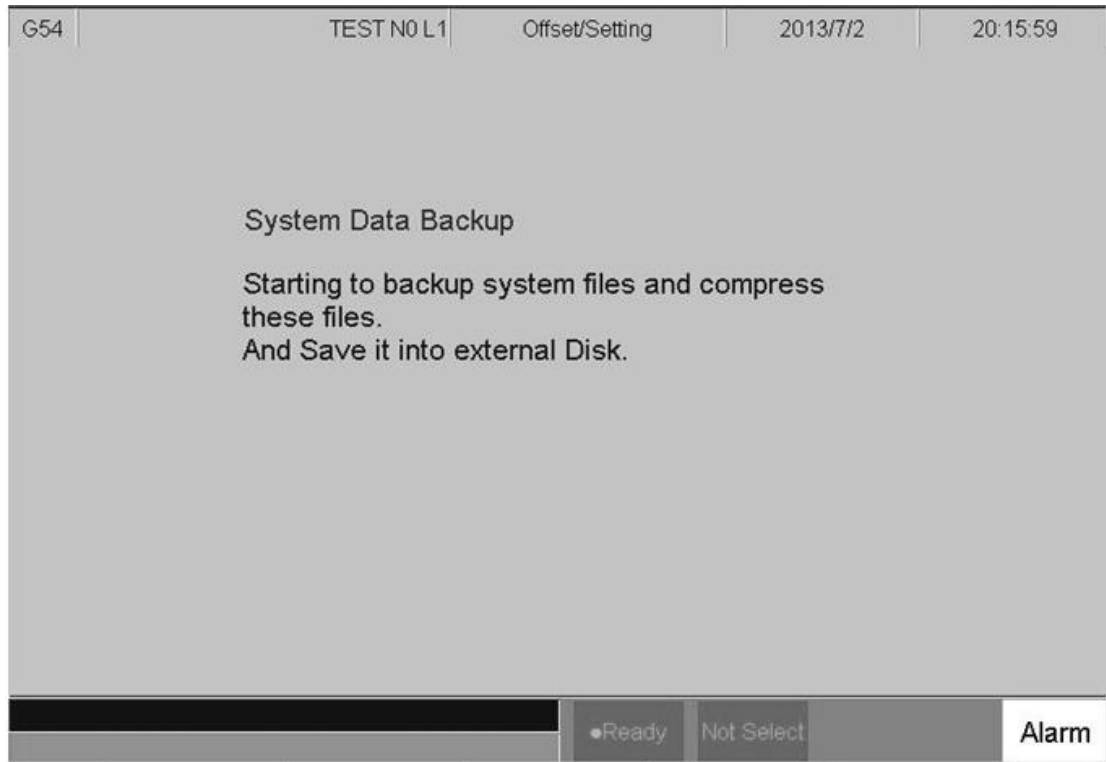

- Path:

- ✧ 5 buttons type: F5 Maintain → Next → F1 Backup system
- ✧ 8 buttons type: F5 Maintain → F6 Backup system

- Description

- ✧ This area executes backup system data.

1.7.7 System permissions

- Path

- ✧ 5 buttons type: F5 Maintain → Next → F3 System permissions
- ✧ 8 buttons type: F5 Maintain → F8 System permissions

- Description

- ✧ Display system data
- ✧ CPU board

- ✧ Serial NO
- ✧ Model Info
- ✧ Machine Type
- ✧ Software Option

1.7.7.1 **Series No Setting**

- Path
 - ✧ 5 buttons type: F5Maintain→Next→F3System
Permissions→F1 Ser. NO setting
 - ✧ 8 buttons type:F5Maintain→F8 System
permissions→F1 Ser. NO setting
- Description
 - ✧ Can set system series
 - ✧ Required to obtain the original setting of the password

1.7.7.2 **Use Time Setting**

- Path
 - ✧ 5 buttons type:F5Maintain→Next→F3System
Permissions→F2 Use time setting
 - ✧ 8 buttons type:F5Maintain→F8System
Permissions→F2 Use time setting
- Description
 - ✧ Can set system series
 - ✧ Required to obtain the original setting of the password

1.7.7.3 Option Setting

- Path
 - ✧ 5 buttons type:F5Maintain→Next→F3System
Permissions→F3 Option setting
 - ✧ 8 buttons type:F5Maintain→F8System
Permissions→F3 Option setting
- Description
 - ✧ Can set optional function
 - ✧ Required to obtain the original setting of the password

1.7.7.4 Op. Info Restore

- Path
 - ✧ 5 buttons type:F5Maintain→Next→F3System
Permissions→F4 Op. Info Restore
 - ✧ 8 buttons type:F5Maintain→F8System
Permissions→F4 Op. Info Restore
- Description
 - ✧ Can restore system Permissions
 - ✧ Required to obtain the original setting of the password

1.7.8 User Login

- Path
 - ✧ 5 buttons type:F5Maintain→Next→Next→F1Login
 - ✧ 8 buttons type:F5Maintain→Next→F1Login
- Description
 - ✧ Enter username and password to login to the system
 - ✧ login different users can have different permissions

- ✧ Permissions can be set in "Authority mangement"

1.7.9 User Logout

- Path
 - ✧ 5 buttons type:F5Maintain→Next→Next→F2Logout
 - ✧ 8 buttons type:F5Maintain→Next→F2 Logout
- Description
 - ✧ logout the accessed account

1.7.10 Forget Password

- Path
 - ✧ 5 buttons type:F5Maintain→Next→Next→F3 Forget Password
 - ✧ 8 buttons type:F5Maintain→Next→F3 Forget Password
- Description
 - ✧ For general user, please contact the manager to reset password.
 - ✧ For mechanery manufacturer or manager, please contact to SYNTEC's customer service.

1.7.11 Authority Management

- Path
 - ✧ 5 buttons type:F5Maintain→Next→Next→F4Authority management
 - ✧ 8 buttons type:F5Maintain→Next→F4Authority management
- Description
 - ✧ Set the authority management of user

1.7.11.1 Change Password

- Path
 - ✧ 5 buttons type:F5Maintain→Next→Next→F4
Authority management→F1Reset password
 - ✧ 8 buttons type:F5Maintain→Next→F4 Authority
management→F1Reset password
- Description
 - ✧ Change the old password
 - ✧ Required to enter the old password

1.7.11.2 Set Authority of Default

- Path
 - ✧ 5 buttons type:F5Maintain→Next→Next→F4
Authority management→F2Set authority of default
 - ✧ 8 buttons type:F5Maintain→Next→F4 Authority
management→F2Set authority of default
- Description
 - ✧ When no user is logged in, the function is enabled

1.7.11.3 Set Authority of Other Users

- Path
 - ✧ 5 buttons type:F5Maintain→Next→Next→F4
Authority management→F3 Set authority of other
users
 - ✧ 8 buttons type:F5Maintain→Next→F4 Authority
management→F3 Set authority of other users
- Description
 - ✧ Machinery manufacture or manager can set each
account permissions

1.7.12 **Reset Password**

- Path
 - ✧ 5 buttons type:F5Maintain→Next→Next→F5Reset password
 - ✧ 8 buttons type:F5Maintain→Next→F5Reset password
- Description
 - ✧ Can reset machinery manufacturer password

1.7.13 About

- Path:

- ✧ F5 Maintain → Next → F5 About

- Description

- ✧ Provide controller software version

2 Machine Operation Panel

2.1 Operation Panel

- POWER ON

- ✧ Turn on controller's power

- POWER OFF

- ✧ Turn OFF power

- Emergency STOP

- ✧ For safety reason of user and machine in case of unusual phenomenon, after this button is pressed, CNC would stop all motion, and all main power. Therefore safety of people and machine will be guaranteed.

- **Home mode**

- Description:

- ◆ When CNC power is on, please implement home search

- Operation:

- ◆ Select HOME mode

- ◆ Press axis manual key X+ or X-, Y+ or Y-, Z+ or Z- or press cycle start

- ◆ CNC would start to return reference position (HOME)

- **JOG mode (Rapid JOG)**

- Operation:

- ◆ Select JOG mode

- ◆ Press X+,X-,Y+,Y-,Z+,Z- key, machine table will move according to axis name and direction
 - ◆ Operators can use JOG% or G01% to adjust Jog feedrate
 - ◆ When operator press both above key and rapid Key “~” at the same time, CNC will move the machine table with “RAPID speed”.
- **Incremental JOG (IN JOG)**
 - Operation:
 - ◆ Select INC JOG mode
 - ◆ Press X+,X-,Y+,Y-,Z+,Z- key, moving distance of machine table equal to the [incremental distance × pressing number of operator]
 - ◆ Operators can set the incremental distance by rotary switch
 - *1 : 1um ,*10 : 10um ,*100 : 100um
- **MPG JOG**
 - Description:
 - ◆ User can use MPG (Manual Pulse Generator) mode to move the machine table
 - Operation:
 - ◆ Select MPG mode
 - ◆ Select incremental rate

- ◆ Select corresponding axis X, Y, Z by rotary switch on MPG device, rotate MPG, machine table will move with velocity according to rotation speed of MPG device.

- **AUTO mode**
 - Description:
 - ◆ Users use this function to execute machining NC file
 - Operation:
 - ◆ Select AUTO mode after returning reference point (HOME)
 - ◆ Set workpiece coor.(G54..G59), CNC will default G54 in case user do not set any workpiece coor.
 - ◆ Excute Tool setting by setting tool wear, tool length, and tool nose
 - ◆ Press “CYCLE START” key to run the NC program.
 - ◆ Press “Feedhold” key to feedhold the NC program if necessary

- **MDI mode**
 - Description:
 - ◆ Users use this function to execute a block without NC file

- Operation:
 - ◆ Select MDI mode
 - ◆ MDI only is enabled after machine returns reference point (HOME)
 - ◆ Select F4 "Monitor"
 - ◆ Press F3 "MDI Input", another interface screen would appear to input program.
 - ◆ Press OK key after finishing input program
 - ◆ Press "CYCLE START" key to execute the MDI block.
 - ◆ If MDI block SYNTAX is incorrect, data in MDI menu will disappear

■ **MPG Simulation**

- Description:
 - ◆ Users can use this function to check NC file
- Operation:
 - ◆ Select AUTO mode
 - ◆ Press MPG simulation button, and the corresponding led will be "ON"
 - ◆ Press "CYCLE START" key to start running NC file.
 - ◆ CNC would change machine status from "READY" to "BUSY"
 - ◆ Machine does not move
 - ◆ Operator can rotate MPG to run NC file

- ◆ The faster MPG rotates, the faster machining speed is
- ◆ MPG stops, CNC stops too.
- ◆ This function can be “Enable” “Disable” immediately
- ◆ P.S. This function is easy to use for checking purpose
- **Dry Run**
 - Description:
 - ◆ User can use this function to check NC file
 - Operation:
 - ◆ Select AUTO mode
 - ◆ Press Dry run button, and the corresponding led will be “ON”
 - ◆ Press “CYCLE START” key to start running the NC file.
 - ◆ CNC will change machine status from “READY” to “BUSY”
 - ◆ This function can be “Enable” “Disable” immediately

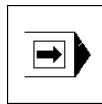

- **Single block**
 - Description:
 - ◆ User can use this function to check NC file
 - Operation:
 - ◆ Select AUTO mode

- ◆ Press single block button, and corresponding led will be “ON”
- ◆ Press “CYCLE START” key to start running the NC file
- ◆ CNC will execute NC file only one block and STOP
- ◆ CNC will change machine status from “BUSY ” to “B_STOP”
- ◆ Press “CYCLE START” again ,then CNC execute next block
- ◆ This function is used to check NC file by checking each Block of NC file.

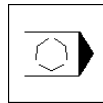

■ **Optional Stop**

● Description:

- ◆ Users can use this function to decide NC file M01 is STOP or not

● Operation:

- ◆ Select AUTO mode
- ◆ Press Optional stop button, and corresponding led will be “ON”
- ◆ Press “CYCLE START” key to run the NC file.
- ◆ When CNC run “M01” code, CNC would STOP

- ◆ CNC would change machine status from “BUSY ” to “Feedhold”
- ◆ This function is used to change tool or check workpiece.

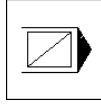

■ **Optional Skip**

● Description:

- ◆ Users can use this function to decide whether program skips or not when program is run to ‘/’ sign in NC file.

● Operation:

- ◆ Select AUTO mode
- ◆ Press Optional skip button, and corresponding led will be “ON”
- ◆ Press “CYCLE START” key to run the NC file.
- ◆ When CNC execute to “/” sign in program ,CNC would Skip this block
- ◆ If this key is not pressed, CNC will execute this block

● Spindle control

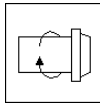

Spindle CW rotation

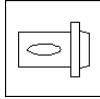

Spindle stop

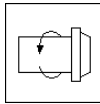

Spindle CCW rotation

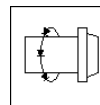

Low spindle speed: When spindle rotates, if this button is pressed, spindle will rotate with low speed

● Working led & Blower

■ Working led ON/OFF

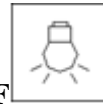

■ Blower ON/OFF



- Working Liquid

- Flush working liquid ON/OFF



- Aux machine table forward

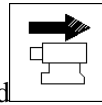

- Aux machine table backward

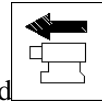

2.2 Text Key Description



~



: 26 English character keys

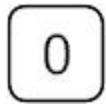

~



: Numerical keys



: Delete key



: Insert /replace key



: Switch keyboard to use smaller key on keyboard



: Space key



: "Backspace" key to delete a character



: "RESET" abort the CNC status, only use this key if necessary



: To input current data to input box



: Enable Help function/message on screen

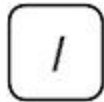

: For optional skip Enterput

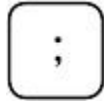

: End of block

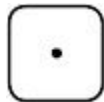

: Decimal fraction

“(, “)”, “[, “]”, “[, “|”, “!”, “&”, “\$”, “#”, “<”, “>”, “=”, “%”, “@”, “*”, “:”, “,”, “+”, “-“

All above symbols are used for “Program Edit” mode.



: Switch cursor to Page Up /Page Down

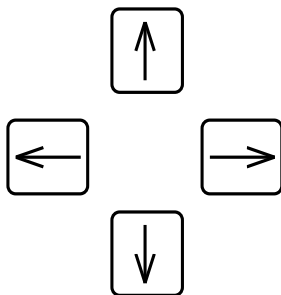

: Edit cursor control key

3 How to Operate 21 Series Controller

3.1 System Status

Syntec's controller will display different status corresponding to different conditions as below:

3.1.1 Not Ready

On Not Ready status, system cannot implement any operations

Conditions:

- ✧ Emergency stop button is pressed
- ✧ Serious alarm appears
- ✧ System is switched to "Not Ready" status and stop all operations to ensure safety of machine and human

3.1.2 Ready

On "Ready" status, system can implement all operations

Conditions:

- ✧ "Emergency stop" button is released and no alarm exists, system is switched "Not Ready" to "Ready" status.
- ✧ On "Busy"/ "Pause"/ "B-stop" status, if user presses "Reset" key; System is switched to "Ready" status.

3.1.3 Busy

System is operating program

Conditions:

- ✧ On "Busy"/ "Pause"/ "B-stop" status, if system executes process; System will be switched to "Busy" status.

3.1.4 Feed Hold

In operational process, system pauses the axis movement

Conditions:

- ✧ Once Feed hold button is pressed when system is on "Busy" status, System will be switched from "Busy" to "Feedhold" status

Note: On "Feedhold" status, Spindle still rotates

3.1.5 B-stop

Conditions:

- ✧ Machine program runs to M0 single block when system is on "Busy" status.
- ✧ Single block function is triggered when system is on "Busy" status.

Note: On "B-Stop" status, Spindle still rotates

3.2 Machine Preparation

3.2.1 Manual Function

SYNTEC controller provides 4 functions used to control axis movement including JOG, INC JOG, MPG and Rapid JOG

3.2.1.1 JOG

- Description:
 - ✧ Control the axis movement X, Y, Z according to selected direction
 - ✧ Can control more than one axis at the same time
- Condition:
 - ✧ System is on “Ready” status
 - ✧ JOG mode is selected
- Operation:
 - ✧ Press axis direction key (X+,X-,Y+,Y-,Z+...)
 - ✧ Hold the axis direction key to keep the axis moving uninterrupted
 - ✧ JOG speed can be adjusted by G01%

3.2.1.2 Rapid JOG

- Description:
 - ✧ Control axis movement X, Y, Z according to selected direction with G00 speed
 - ✧ Can control more than one axis at the same time
- Condition:
 - ✧ System is on “Ready” status
 - ✧ JOG mode is selected
- Operation:
 - ✧ Press axis direction key (X+,X-,Y+,Y-,Z+...) and rapid key “~” “at the same time ,machine will move with G00- rapid speed
 - ✧ Hold the axis direction key to keep the axis moving uninterrupted
 - ✧ Rapid JOG speed can be adjusted by G00%
- Note:
 - ✧ Rapid JOG is usually much faster than JOG, so when operating, please confirm the axis position to ensure human and machine safety.

3.2.1.3 INC JOG (incremental JOG)

- Description:
 - ✧ Control axis movement X, Y, Z according to selected direction with fixed distance(incremental distance)

- Condition:
 - ✧ System is on “Ready” status
 - ✧ INC JOG mode is selected
- Operation:
 - ✧ Press axis direction key (X+, X-,Y+,Y-,Z+...)
 - ✧ Cannot be constantly triggered like JOG or rapid JOG mode, INC JOG mode only moves once with a fixed distance when axis direction key is pressed once.
 - ✧ The fixed distance in INC JOG mode can be selected by percentage movements as below:
 - X1 : Distance 0.001mm
 - X10 : Distance 0.010mm
 - X100 : Distance 0.100mm

Those percentage movements is shared with MPG mode

3.2.1.4 MPG

- Description:
 - ✧ Control axis movement X, Y, Z according to selected direction
- Condition:
 - ✧ System is on “Ready” status
 - ✧ MPG mode is selected
- Operation:
 - ✧ Press axis direction key (X+, X-,Y+,Y-,Z+...)
 - ✧ Cannot be constantly triggered like JOG or rapid JOG mode, INC JOG mode only moves once with a fixed distance when axis direction key is pressed once.
 - ✧ The moving distance when turning one track in MPG mode can be selected by percentage movements as below:
 - X1 : Distance 0.001mm
 - X10 : Distance 0.010mm
 - X100 : Distance 0.100mm

SYNTEC

- ✧ Those percentage movements is shared with INC JOG mode

3.2.2 Machining Process

3.2.2.1 Auto

- Condition:
 - ✧ System is on “Ready” status
 - ✧ AUTO mode is selected
- Operation:
 - ✧ Press CYCLE START button
 - ✧ System will machine the current machining program
 - ✧ System status will be switched from “Ready” to “busy” and backs to “Ready” when machining is finished

3.2.2.2 Single Block

- Description:
 - ✧ Excute each single block in program
- Condition:
 - ✧ System is on “Ready” status
 - ✧ Single block mode is selected
- Operation:
 - ✧ Press CYCLE START button
 - ✧ System will excute process the current single block in program
 - ✧ System status will be switched from “Ready” to “busy” and backs to “Ready” when machining is finished

3.2.3 HOME

Because tool and workpiece coordinate setting is based on Machine zero point, it is necessary to make sure where is machine zero (HOME). Therefore, when CNC restarts, return to reference point (search HOME) is very important. Otherwise, SYNTEC CNC controller will not be allowed to execute AUTO NC files.

- Operation:

- ✧ Release emergency stop button, CNC status will change “NOT READY” to “READY”
- ✧ Select HOME mode
- ✧ Press axis direction key(X+,X-,Y+,Y-,Z+...) ,each axis would start HOMING
- ✧ Home direction is defaulted in the CNC parameter
- ✧ Home function can run 3 axes at the same time
- ✧ After HOMING, all machine coordinates will be zero.
- ✧ After HOMING, software stroke limit of each axis just is enable, so before HOMING, please do not run machine too fast.

3.3 Tool Preparation

When programming and editing machining program, user usually write Gcode related to tool and workpiece, and does not care about the real position. Moreover, tool length is different between each cutting tool, so tool preparation is necessary to avoid disturbing caused by different tool length.

Syntec lathe controller provides: tool length set, tool wear set, tool nose set and working shift.

3.3.1 Tool Length Set

G54	TEST N-1 L1	Offset/Setting	2013/7/2	19:43:43
Input Mode (A)bsolute (I)ncrement			Machine	
Absolute			X	100.000
	XLength	YLength	Z	100.000
	ZLength		Y	100.000
1	0.000	0.000	Absolute	
2	0.000	0.000	X	-20.000
3	0.000	0.000	Z	100.000
4	0.000	0.000	Y	100.000
5	0.000	0.000	Relative	
6	0.000	0.000	X	100.000
7	0.000	0.000	Z	100.000
8	0.000	0.000	Y	100.000
			●Ready	Not Select
			Alarm	

● Path:

■ F3 Offset/Setting → F2 Tool length set

- ✧ Switch the cursor to the position wants to set by using page up/down keys and arrow keys
- ✧ There are 3 methods to input: absolute, incremental and teaching
- ✧ Enter 「 A*** 」 to input absolute value, here *** is input value; generally, this method is used to input tool radius compensation or tool length compensation.
- ✧ Enter 「 I*** 」 to input incremental value, here *** is input value; generally, this method is used to input tool radius wearing compensation or tool length wearing compensation.

- ✧ Enter 「X***」 or 「Z***」 to input teaching value.
User can input other axis name as Y, X1, X2, here
*** is teaching value; generally, this method is used
to input tool length compensation.
- ✧ Formula calculated compensation value
- ✧ Tool radius + radius wear) is real G41/G42
compensation value
- ✧ (Tool length + length wear) is real G43/G44
compensation value
- ✧ Using teaching method, user does not need to move
cursor to desired input position, only need move
cursor to right tool number and enter axis name,
controller will automatically enter setup value
according to axis name.
- ✧ After setting tool length by teaching method, tool
wear value is set to zero automatically.

3.3.2 Tool Length Measurement

Once NC file has T code, G43 will enable automatically. Therefore, users must set tool length before machining.

Before measuring, please confirm whether working shift(G92)and workpiece coordinate system is correct

3.3.2.1 Z axis tool length measurement

G54	TEST N-1 L1		Offset/Setting
Input Mode (A)bsolute (I)ncrement			
Absolute			
	XLength	YLength	ZLength
1	0.000	0.000	0.000
2	0.000	0.000	0.000
3	0.000	0.000	0.000

Use MDI mode and enter the tool No. want to measure. For example: T0101

- Path:

- ✧ F3 Offset/Setting → F2 Tool length set

- Operation:

- ✧ Move cursor to tool No. wants to set tool length, ex tool No. 1

- ✧ Use manual mode (JOG, INJOG, MPG mode) to move the cutting tool until it touches the Z axis workpiece zero point. Use teaching input method 「Z0」 to set current workpiece zero point position.

- ✧ Input Z axis cutting measuring

- ✧ Normally, it is not easy to move cutting tool until it touches the Z axis work piece zero point. In this case, user usually inputs Z axis cutting measuring

● Operation

- ✧ Clamp the round workpiece by spindle
- ✧ Use manual mode to move tool nose touch of workpiece end face, ensure that workpiece can be cut by moving X axis
- ✧ Spindle rotates CW direction, using MPG mode to move X axis in direction that can cut workpiece
- ✧ Move X axis in invert direction, do not move Z axis
- ✧ Use teaching input method, enter 「Z0, the workpiece end face that just is cut is the workpiece zero point.

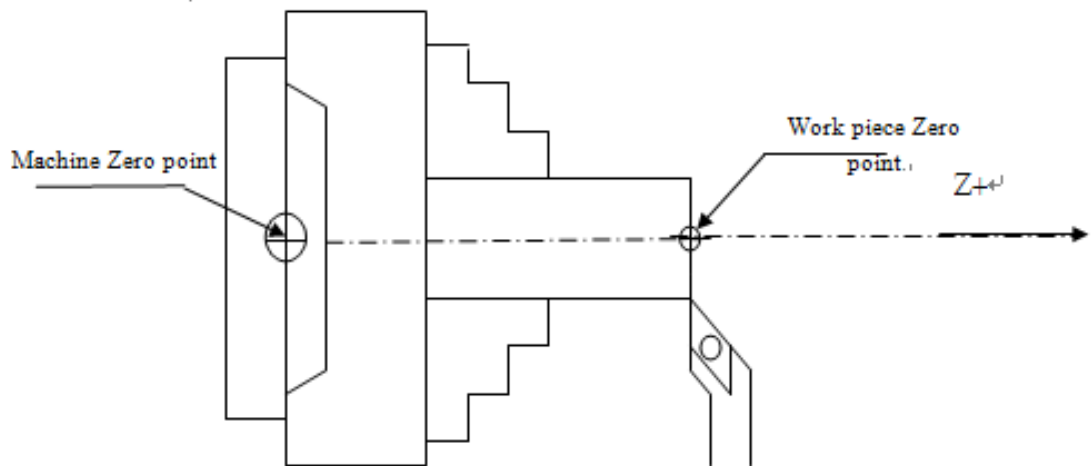

- ✧ Note: After setting Z axis tool length by teaching method, Z axis tool wear value is set to zero automatically.

3.3.2.2 X axis Tool Length Measurement

- ✧ Input X axis cutting measuring
- ✧ Normally, it is not easy to move cutting tool until it touches the X axis work piece zero point. In this case, user usually inputs X axis cutting measuring
- Operation:
 - ✧ Use MDI mode and enter the tool No. wants to measure. For example: T0101
 - ✧ Path: F3 Offset/Setting → F2 Tool length set
 - ✧ Move cursor to tool No. wants to set tool length, ex tool No. 1
 - ✧ Use manual mode (JOG, INJOG, MPG mode) to move the cutting tool until it touches the X axis work piece zero point. Use teaching input method 「X0」 to set current workpiece zero point position.
- Example
 - ✧ Clamp the round workpiece (diameter14mm) by spindle, ensure workpiece can be cut by moving cutting tool along Z axis
 - ✧ Rotary spindle, Cut a distance along Z axis
 - ✧ Retract cutting tool along Z axis, do not move X axis
 - ✧ Measure cutting diameter “D “
 - ✧ Input this teaching value “X+/-D”. For example, after cutting, the workpiece diameter is 13.5mm, input X13.5

- ✧ The plus/minus sign is decided by tool tip position, if tool tip is located at X+ (tool tip is located above central line), sign is “+”, if tool tip is located at X-, the sign is “-“

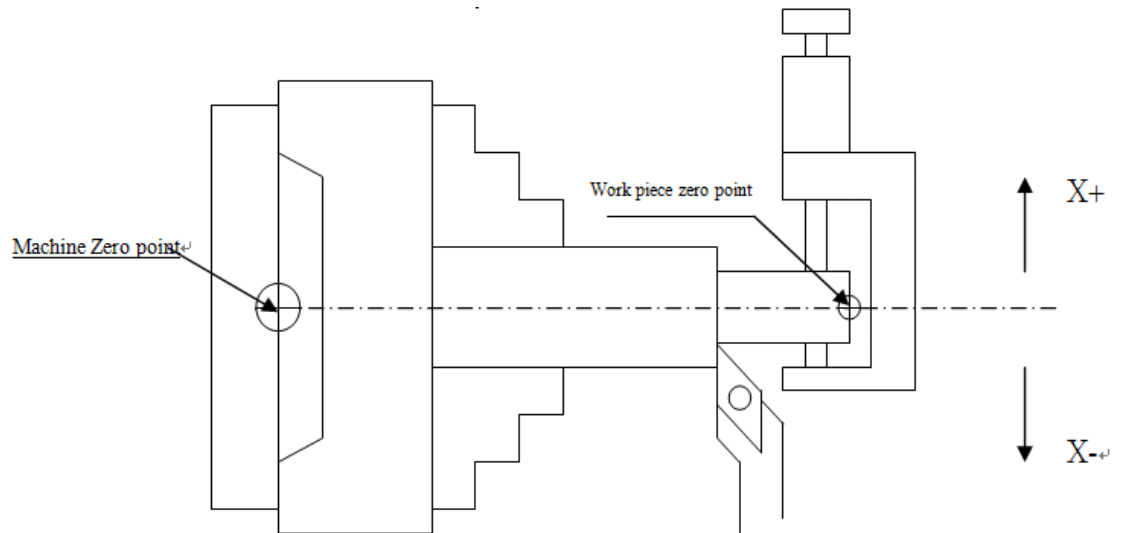

● Note:

- ✧ After setting Xaxis tool length by teaching method, X axis tool wear value is set to zero automatically.

3.3.2.3 Tool Wear Setting

Tool wear setting commonly used to compensate tool wear, tool expansion and contraction caused by thermal, or corrects the tool length in fine machining process. After completing tool length setting, do not modify tool length value randomly, only use tool wear setting to correct the size workpiece in fine machining process.

After setting tool length, tool wear value is set to zero automatically. If machining result has error, users can use tool wear function to compensate tool length. Actually, tool length = tool length + tool wear

G54	TEST N-1 L1	Offset/Setting	2013/7/2	19:39:48
Input Mode (A)bsolute (I)ncrement			Machine	
Absolute			X 100.000	
	XWear	YWear	ZWear	Z 100.000
1	0.000	0.000	0.000	Y 100.000
2	0.000	0.000	0.000	Absolute
3	0.000	0.000	0.000	X -20.000
4	0.000	0.000	0.000	Z 100.000
5	0.000	0.000	0.000	Y 100.000
6	0.000	0.000	0.000	Relative
7	0.000	0.000	0.000	X 100.000
8	0.000	0.000	0.000	Z 100.000
INC: +/-1.000			●Ready	Not Select
			Alarm	

- Path:

- ✧ F3 Offset/Setting → F1 Tool wear set

- Input method

- ✧ Absolute: input the absolute value of tool wear by entering "A**". Tool wear would equal this value

- ✧ Incremental: enter tool wear incremental value by entering "I** ". Tool wear will be changed to pre-value plus this value

- ✧ Input mode: only need to input “A” or “I” single character, then “absolute “or “incremental” setting would be kept, then users can directly input only setting value.
- ✧ plus/minus sign +/- :
- ✧ Input value can be assigned sign “+/-”
- ✧ The plus/minus sign is decided by adjusted direction of tool tip.
- ✧ If adjusted direction of tool tip is “Plus” direction, then enter tool wear value with plus sign
- ✧ If adjusted direction of tool tip is “minus” direction, then enter in tool wear value with minus sign

- Example:

If machining result is bigger than diameter 10um, tool tip is adjusted to X- , then input “I-0.01” to tool wear. -10um diameter will be added to current tool wear value. The next cutting time, tool tip cutting path would move toward “X-” direction 10um in diameter.

- Parameter

No	Descriptions	Range	Unit	initial	occasion
3245	Max inc. value of input for tool wear compen.(BLU)	[1~200000]	BLU	1000	reset

Set the param to limit the value of input for tool wear compention to avoid collide.

3.3.2.4 Tool Nose Setting

Tool nose is circular, however; tool length measurement only measures tool length, so for precision machining, users can set tool nose to compensate tool nose dimension error, operation method are shown as below:

- Path:

✧ F3-Offset/setting→ F3 tool nose set

G54	TEST N-1 L1	Offset/Setting	2013/7/2	19:46:48
Input Mode (A)bsolute (I)ncrement			Machine	
Absolute			X 100.000	
Radius R.Wear Nose			Z 100.000	
1	0.000	0.000	0	Y 100.000
2	0.000	0.000	0	Absolute
3	0.000	0.000	0	X -20.000
4	0.000	0.000	0	Z 100.000
5	0.000	0.000	0	Y 100.000
6	0.000	0.000	0	Relative
7	0.000	0.000	0	X 100.000
8	0.000	0.000	0	Z 100.000
			Y 100.000	
			●Ready	Not Select
			Alarm	

- There are 3 kinds tool nose data to input
 - ✧ Radius: tool nose radius
 - ✧ R.wear: tool nose radius wear, real tool nose equals to (Radius+R.wear)
 - ✧ Nose: Depending on tool nose shape, there are 8 tool nose directions to be selected. Please see SYNTEC programming manual to know more detail (G41/G42).
 - ✧ Using G41/G42 in NC files to enable tool nose compensation

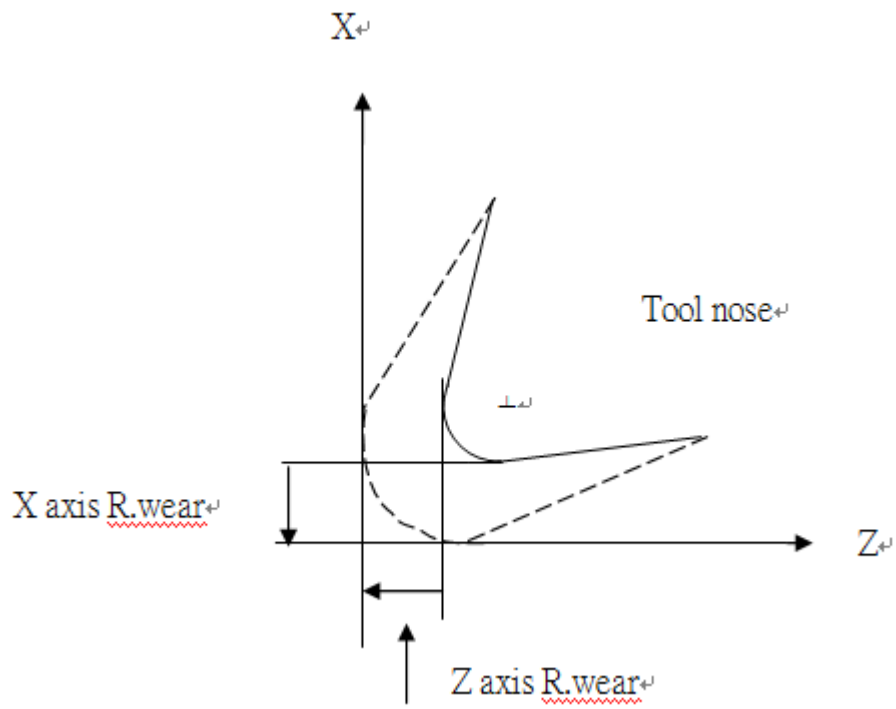

3.3.3 Working Shift

During writing program process, user often uses the workpiece coordinate system, it needs to set properly in CNC before machining. Machining program will modify the relation between the workpiece coordinate and machine coordinate system according to different workpiece coordinate system shift

- Syntec's controller provides 2 methods to set workpiece coordinate system
 - ✧ Use NC program or MDI execute G92 code
 - ✧ Use working shift function
 - ✧ Working shift function
- Path:
 - ✧ F3-Offset/Setting → F5 working shift

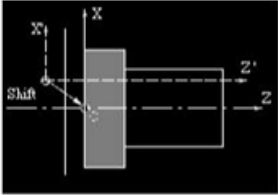
G54	TEST N-1 L1	Offset/Setting	2013/7/2	19:47:32	
Input Mode: Incremental			Absolute		
Shift Amount			X	-20.000	Z
X	0.000		Y	100.000	
Z	0.000				
Incremental			Machine		
1. Move cursor to X or Z field			X	100.000	
2. Input increment value			Z	100.000	
Absolute			Y	100.000	
1. Input X*** to set X absolute position					
2. Input Z*** to set Z absolute position					
Can't set in busying, execute G92 will change shift amount!					
		●Ready	Not Select	Alarm	

- Working shift function has 2 input methods.
 - ✧ Incremental : Move cursor to axis wants to set, enter offset value. This value describes the offset relation between absolute coordinate and machine coordinate.

✧ Absolute : Enter 「X***」 or 「Z***」. 「***」

means absolute coordinate value of current position.

3.3.4 Tool Manager Function

Purpose: Record the status of all cutting tool on machine, make users know whether cutting tool reached to Max. Life, avoid machining in case cutting tool is broken. This function needs a related PLC setting. In case, cutomers need to use this function, please contact to machine maker.

G54		TEST NO L1		Offset/Setting		2013/7/2		20:18:05	
Tool Manager Function									
No	Turret group	Information	Cur. Life	Max. Life	Announce	Status			
01	0	U N C -	0	0	0	No Managed			
02	0	U N C -	0	0	0	No Managed			
03	0	U N C -	0	0	0	No Managed			
04	0	U N C -	0	0	0	No Managed			
05	0	U N C -	0	0	0	No Managed			
06	0	U N C -	0	0	0	No Managed			
07	0	U N C -	0	0	0	No Managed			
08	0	U N C -	0	0	0	No Managed			
09	0	U N C -	0	0	0	No Managed			
10	0	U N C -	0	0	0	No Managed			
11	0	U N C -	0	0	0	No Managed			
12	0	U N C -	0	0	0	No Managed			
(0-96) Turret tool No.					●Ready	Not Select	Alarm		

● Condition

- ✧ Both auto and manual can be use.
- ✧ Operation
- ✧ Pr.3228 is the on/off control of 「 Tool management 」

● Description

- ◆ Turret
 - ✧ Current tool case no. that tool located.
- ◆ Group
 - ✧ Same kind of tool within in one group, if the first tool of that group is on lock state or 「 Tool life 」 is end,

whenever user use T code to change the tool, system will skip the first tool and use the second one, when the second one is lock or 「 Tool life 」 is end, will use the third one, and so on.

◆ Tool informations (Status)

✧ L—Lock / U—Unlock

✧ If the status of tool is lock, that tool can't be use and when T code is use to change the tool, system will skip that tool.

✧ B—Large diameter Tool/ N—Normal Diameter Tool

✧ Adjacent side of large diameter tool set is empty(for display)

✧ T—working time T / C—Number of working times

✧ Decide the current life time, the maximum life time, life time prediction, unit of timing and number of time.

✧ R—effective value / - —non effective value.

✧ Current tool are using tool management or not.

◆ Current Life time

✧ Current Tool Using Condition

◆ Maximum Life Time

✧ Maximum lifetime of tool.

◆ Lifetime prediction

✧ when lifetime of tool is greater than lifetime prediction, alarm will be show up.

◆ Current Status of Tool

- ✧ (0) Without management: Set values are not effective.
- ✧ (1) Without use: Lifetime of tool is zero.
- ✧ (2) usable: $0 < \text{Tool Life Time} < \text{lifetime prediction}$
- ✧ (3) End prediction: $\text{Lifetime prediction} < \text{Tool Lifetime} < \text{Maximum Lifetime}$
- ✧ (4) End of Life: $\text{Maximum Lifetime} < \text{Tool Lifetime}$
- ✧ (5) ware of tool

3.4 Program Preparation and Execute Machining

3.4.1 Specifying Machining Program

- Condition
 - ✧ Except single block mode
- Operation
 - ✧ Specify current edit program as machining program
 - ✧ Switch to edit page
 - ✧ Select F1-Excute, and the program will be designated as the machining program
 - ✧ Specify machining program in file manager.
 - ✧ Switch to the "File Management" page
 - ✧ Move the cursor to the expected program and press Enter
 - ✧ Select F1-Excute, and the program will be designated as the machining program
- Confirmation:
 - ✧ There are two ways to confirm whether machining program is specified successfully.
 - ✧ The screen displays the correct machining program name
 - ✧ The content of machining program is displayed when pressing F4-Monitor

3.4.2 Simu. Setting

Syntec's controller provides simulation program, after editing machining program, users can easily simulate the path machining process, this feature also contains checking features that help users to quickly verify the syntax error in machining program or unreasonable actions, we suggest users should use this function to check machining program.

- Condition
 - ✧ Except single block mode
- Operation
 - ✧ In the “File Management” page, select the program you want to edit after completing edit program, press F5-Simulation
 - ✧ Screen will switch to the “graphic simulation” page and scan the contents of the program
- Detail description
- Simulation screen
 - ✧ The solid line represents the cutting path
 - ✧ The dashed line represents the moving path
 - ✧ In the scanning process, if there is any syntax or content error, they will be displayed on the screen with corresponding error line number.
 - ✧ F1-step: To simulate tool path corresponding to single block in NC files. It is used for coordinate checking purpose.
 - ✧ F2-Continue: System scans the whole program first before executing simulation.
 - ✧ F3-zoom: To zoom in/out the workpiece graph. Users can use the arrow key “←”, “↑”, “→”, “↓” to move

the frame to the determined area, use “PageUp”
“PageDn” to zoom in/out this area. After selecting
zoom scales, press “enter” to finish.

✧ F5- simu. Setting: To set simulation parameter

3.4.3 Machining Test

3.4.3.1 MPG Simulation

- Condition
 - ✧ Only for single block and auto mode
- Operation
 - ✧ Select Auto mode
 - ✧ Press MPG simulation button on operation panel
 - ✧ Turn MPG to execute machining
 - ✧ If MPG is turned in CW direction, Program will be run from current NC line down to below NC line
 - ✧ If MPG is turned in CCW direction, Program will be run from current NC line up to above NC line
- Confirmation
 - ✧ There are two ways to confirm whether MPG simulation is boot successfully.
 - ✧ After enable MPG simulation function and not machining: check whether G01 override on [monitor screen] is 0 when not rotating MPG, unequal to 0 when rotating MPG
 - ✧ After enable MPG simulation function and during machining process : whether Machine immediately decelerates to 0 until turn MPG or cancel MPG simulation mode

3.4.3.2 Single Block

- Condition

- ✧ Only for single block and auto mode
- Operation
 - ✧ Select Auto mode
 - ✧ Press single block button on operation panel
 - ✧ After programming and decelerating to 0, system status changes to B-stop
 - ✧ Press CYCLE START again
 - ✧ After completing next single block in NC file, system will be on B-stop status again

3.4.4 Machining Monitor

This section will introduce how to execute the function of part count and work record

3.4.4.1 Part count Manager

- Description

1. Total accumpart

- ✧ The total accumulative part machined by CNC

2. Required part count

- ✧ Once machining program specifies the needed workpiece number, and CNC continues machining when it meets M99, if the demand workpiece number is reached, machining process will be paused and notification message will be displayed.

3. Part count

- ✧ Once CNC continues machining when it meets M99, this number will be accumulated until reset

- Part count reset (clear to 0) condition

- ✧ Required part count is reached

- ✧ Change machining files

- ✧ Modify the required part count, and the required part count is smaller than part count.

3.4.4.2 Work Record Function

- Description
 - ✧ Once CNC continues machining when it meets M99, work record function will automatically record status
- Work record condition
 - ✧ Required part count is reached
 - ✧ Change machining files
 - ✧ Modify the required part count, and the required part count is smaller than part count.

3.5 Alarm Processing

In order to avoid wrong operation effects on safety of human and machine, the system and PLC have many kinds of protection. When these protection conditions are triggered, the system will issue warning or alarm to users. This section will describe how to view and troubleshooting alarm.

3.5.1 Emergency Stop

Machine failure or unexpected movements may cause unsafety for human and machine. Pressing emergency stop button, you can immediately stop the machine.

3.5.2 Alarm Display

Alarm is basically divided into the pending alarm and history alarm.

3.5.2.1 Pending Alarm

- ✧ The current status of system alarm
- ✧ Once an alarm occurs, the controller will issue alarm and display the current alarm content on screen
 - Press ESC to jump that window
 - If the alarm still is not removed, press reset button, alarm window will be not displayed.
 - Press F5-Maintain to display pending alarm contents.

3.5.2.2 History Alarm

Accessing into this page enables user to see all system alarms which have occurred, so users may find out the alarm reason.

- Path:
 - ✧ F5- maintain → F1-Alarm → F2 History alarm
 - ✧ Display history alarm

The smaller No. alarm is, the sooner alarm occurs

3.5.3 Save Alarm

In case users need support from machinery manufactory to repair once alarm appears, users can export the alarm contents to an external storage device, and send it to machinery manufactory. By that way, they could clarify and find out the possible reasons.

- Operation

- ✧ Insert the external storage device into controller, or set the corresponding network folder
- ✧ Switch to “Alarm” page(F5-maintain→F1-alarm)
- ✧ To export the pending alarm, press F1-pending alarm→ F3-save alarm
- ✧ To export the history alarm, press F2-history alarm→ F3-save alarm
- ✧ External storage device will be displayed on screen, select the destination folder to save
- ✧ Select OK to complete export alarm content

- File name

- ✧ Actual alarm : Actalm.txt
- ✧ History alarm : Histalm.txt

3.6 Network Setting

- A. On the interface screen, press down “F5 Maintain” => “F2 Network setting” to access IP address setting.
- B. **IP Address Setting:** select “Specify an IP Address” when the PC connects with controller directly. And select “Obtain an IP Address via DHCP” if using network connection via Dynamic Host Configuration Protocol
- C. **IP Address:** if you select “Specify an IP Address”, enter the free IP address

The screenshot shows a window titled "Network Setting" with a close button (X) in the top right corner. The window is divided into several sections:

- IP Address Parameter:**
 - IP Address Setting: A dropdown menu with a downward arrow.
 - IP Address: A text input field with a dropdown menu showing "Specify an IP Address" (highlighted) and "Obtain an IP Address via DHCP".
 - Subnet Mask: A text input field.
 - Primary DNS: A text input field.
 - Default Gateway: A text input field.
 - Primary WINS: A text input field.
- Network Disk Remote Host Path:**
 - PC Name: A text input field.
 - Dir Name: A text input field.
 - User Name: A text input field.
 - Password: A text input field.
- Net Status:** A text input field containing "Code : -1".
- Resource Shared:**
 - Shared Folder Path: A text input field.

- D. **Subnet mask:** Enter the IP address for subnet mask (the same with PC subnet mask).
- E. **PC Name:** Enter the full computer name of your PC.
- F. **Dir Name:** Enter the sharing folder name (the same name with PC sharing folder)
- G. **User Name:** Enter GUEST
- H. Press 「F1 OK」, and then reboot controller to finish installation.

3.7 PC Setting

3.7.1 XP OS

1. Guest account setting

Log in as Administrator and select “start”→ “control panel”→”user account”→ Guest



2. Sharing resource setting

- Right click the folder you want to share and select “Sharing and security”
- Click on “If you understand security risks but want to share files without running the wizard, click here”

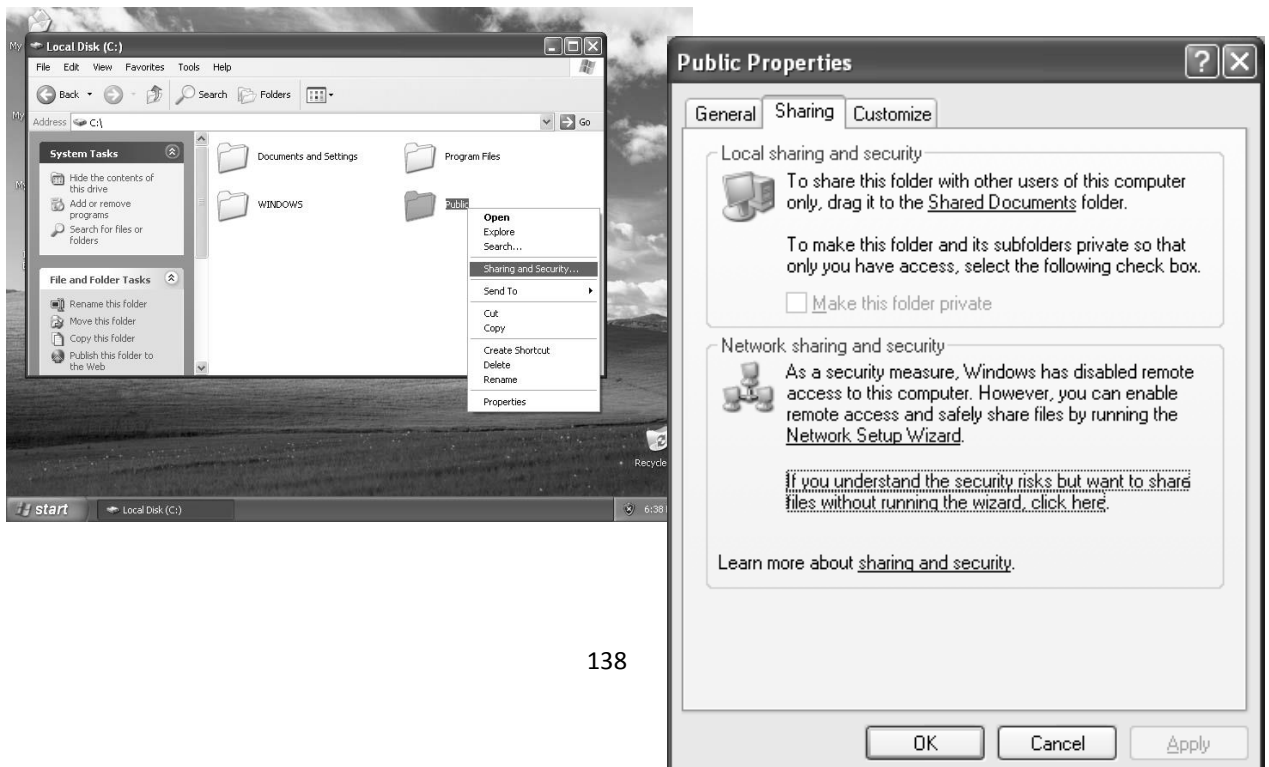

3. Click “OK” to confirm sharing setting; Select “Share this folder on the network”, and “Allow network users to change my files”.

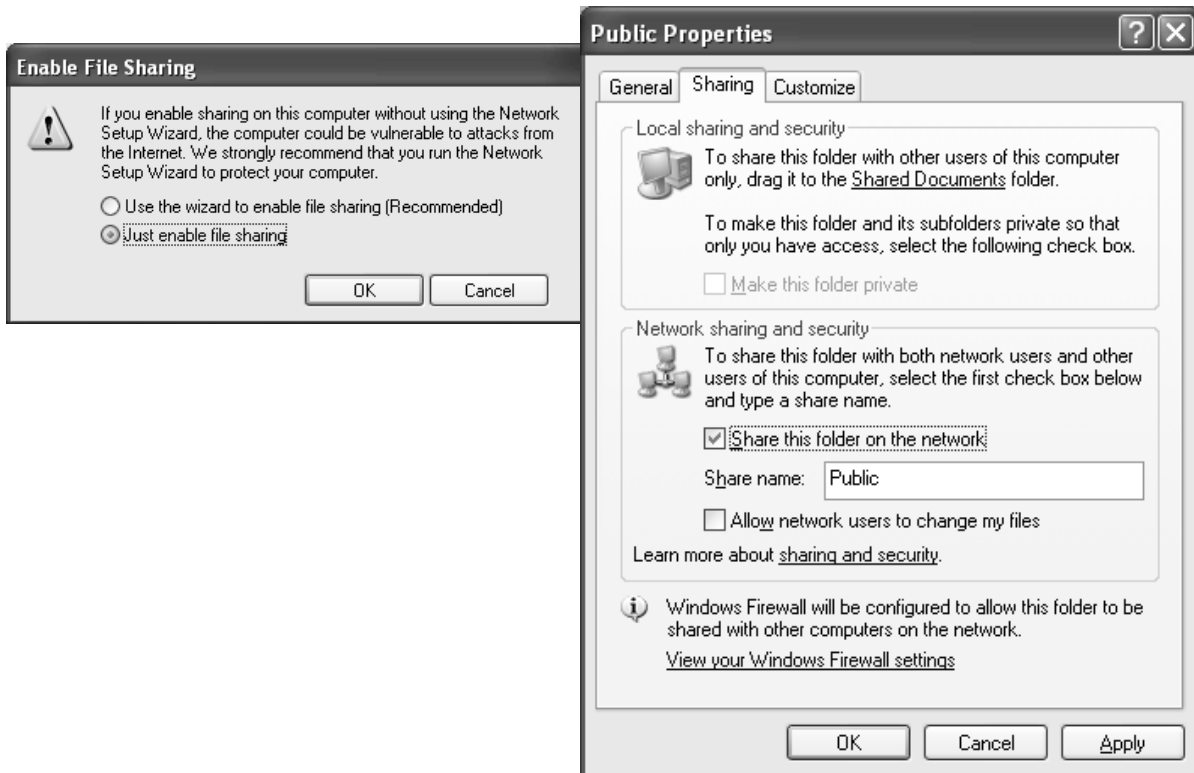

4. Setting PC name and workgroup

“Start”→ “control panel”→”System”→ “change” to set “Computer Name” and “Workgroup”, and remember these setting contents to use later on when setting controller.

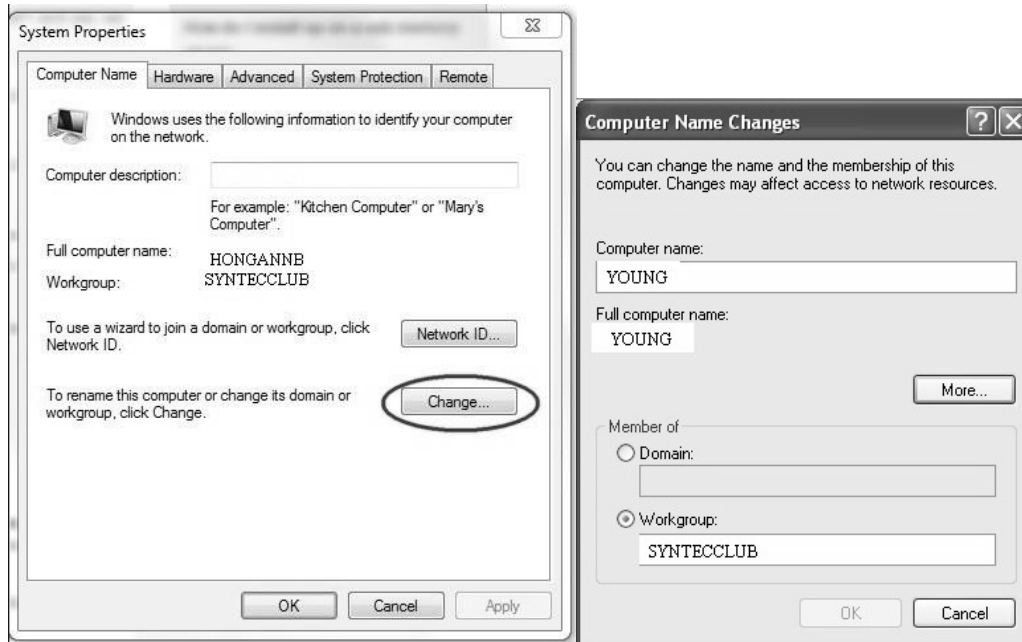

5. TCP/IP setting

“Start” => “Setting” => “Network connections” and right click on “Properties”, and

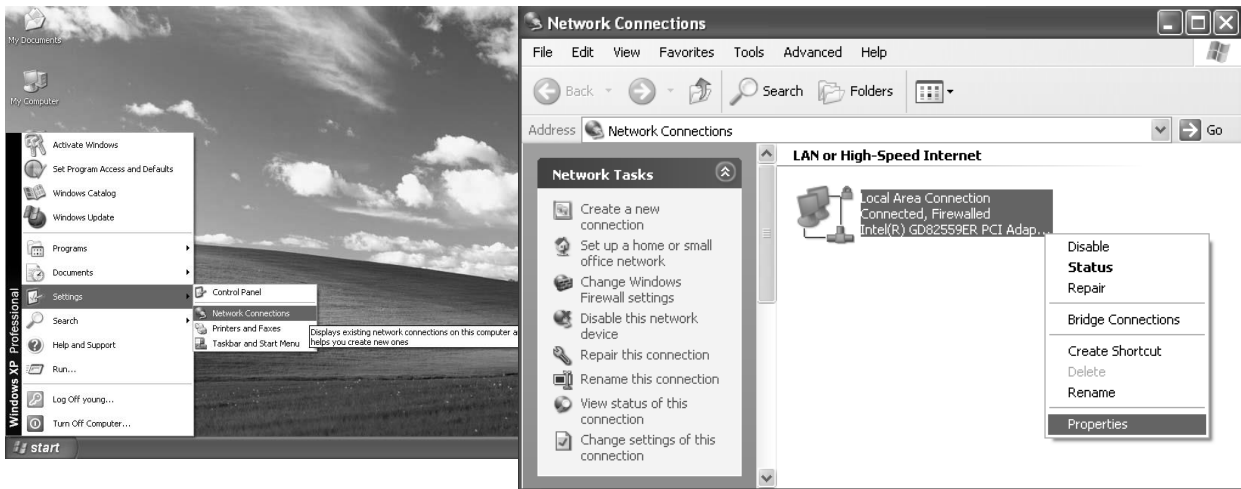

select “Internet Protocol [TCP/IP]”

- ✧ Jumper cable (without HUB), select “use the following IP address” and enter IP address (the forth number is different from controller setting) and Subnet mask (same with controller setting)
- ✧ Network cable (with HUB), select “Obtain an IP address automatically”

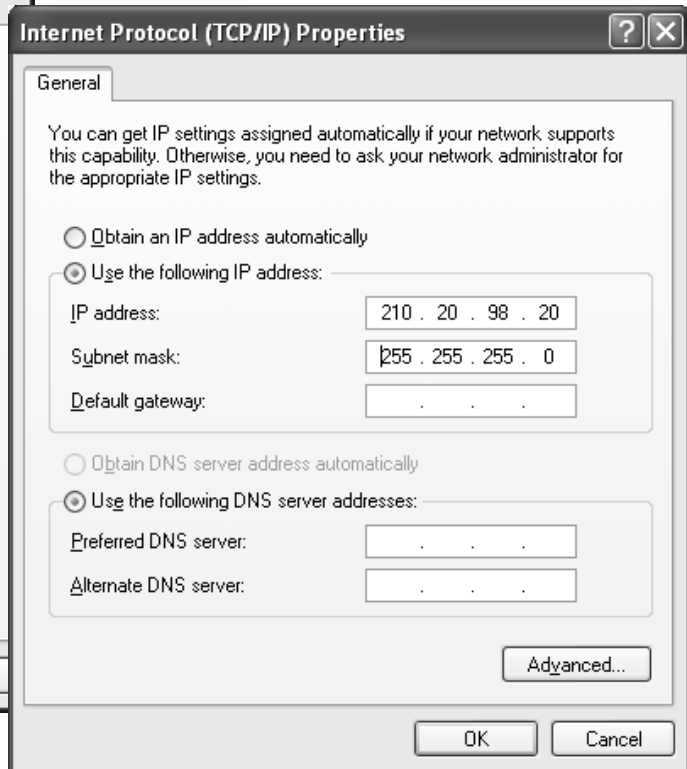
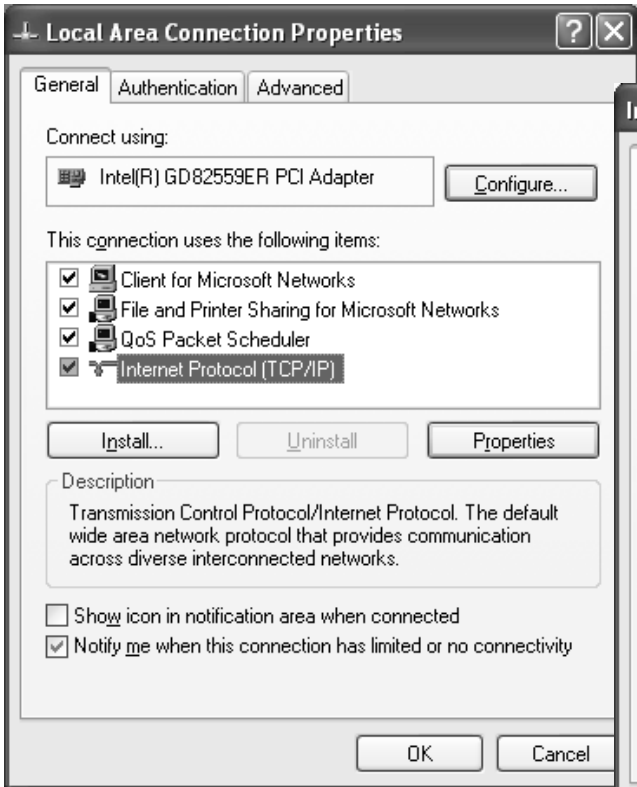

3.7.2 VISTA OS

1. Guest account setting

Log in as Administrator and select “start” → “control panel” → “user account” → Guest



2. Sharing resource setting

Create a sharing folder, and change this folder's setting to offer controller to use, as the below figure.

- A. Click on "advanced sharing"
- B. Click on "share this folder"

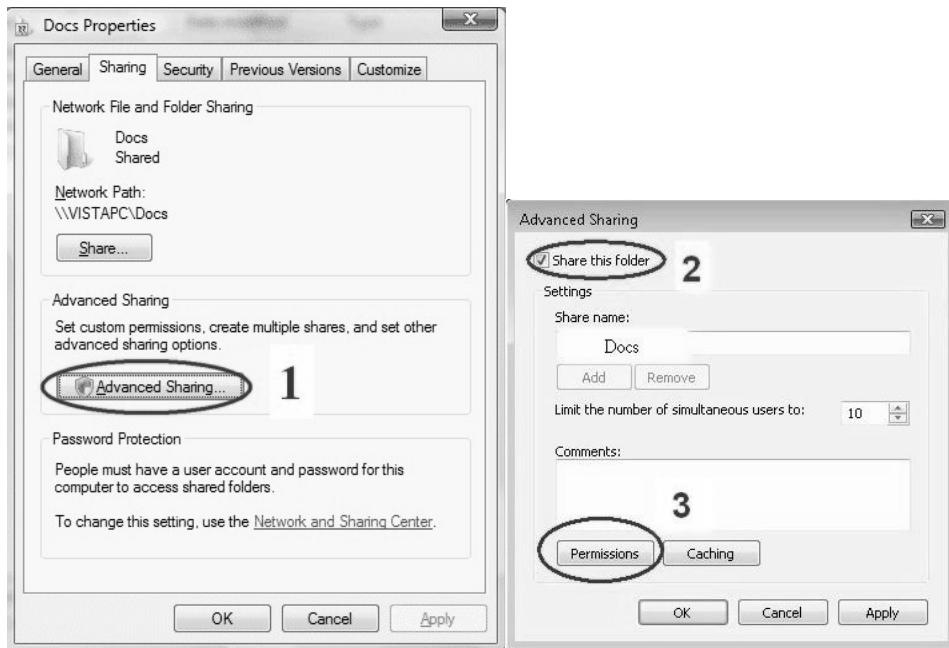

- C. Click on "permission"
- D. Click on "add"
- E. Enter "GUEST" as the new group name, click "OK" to complete setting

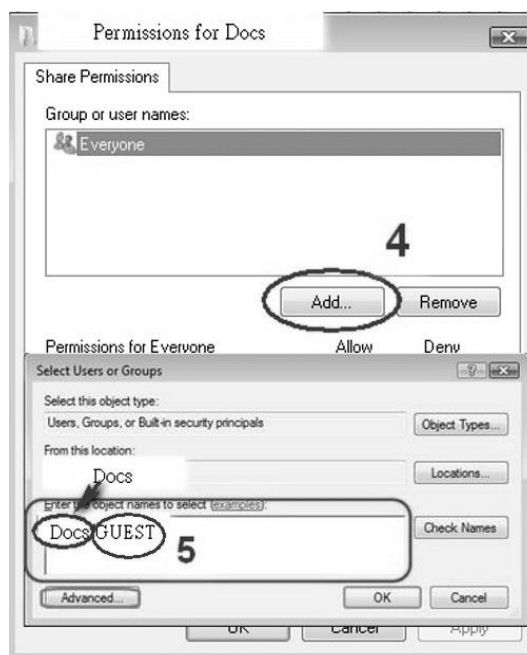

3. Security setting

Right click on folder to share → properties → security → Edit → add “Guest” as a new group, then open group permissions to maximum.

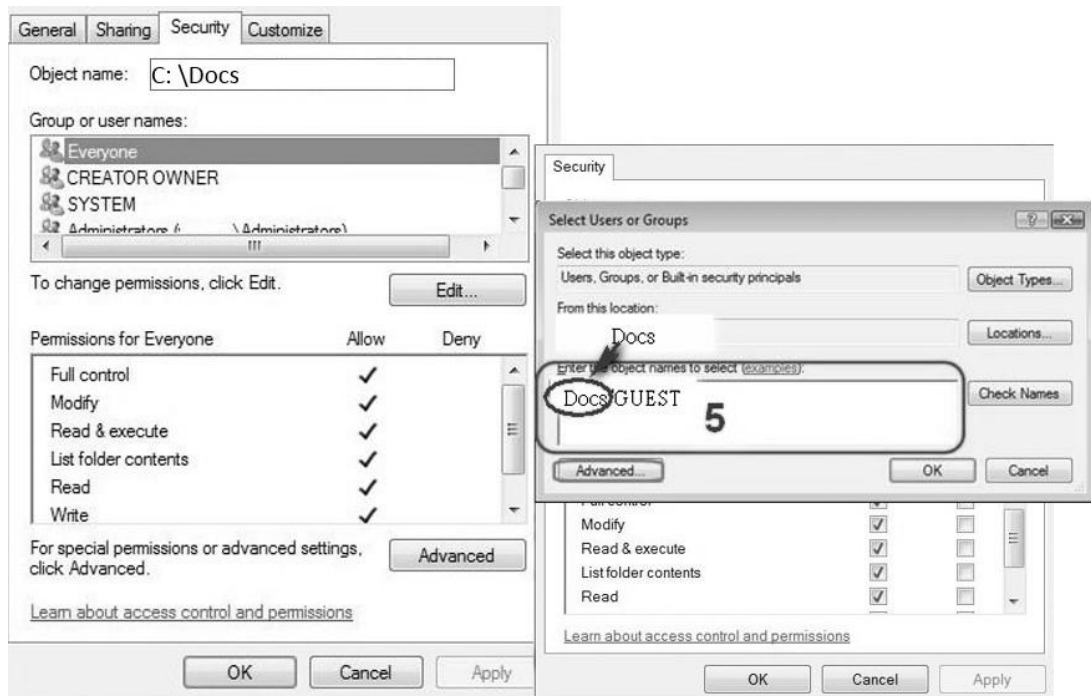

4. Setting PC name and workgroup

“Start” → “control panel” → “System” → “change” to set “Computer Name” and “Workgroup”, and remember these setting contents to use later on when setting controller.

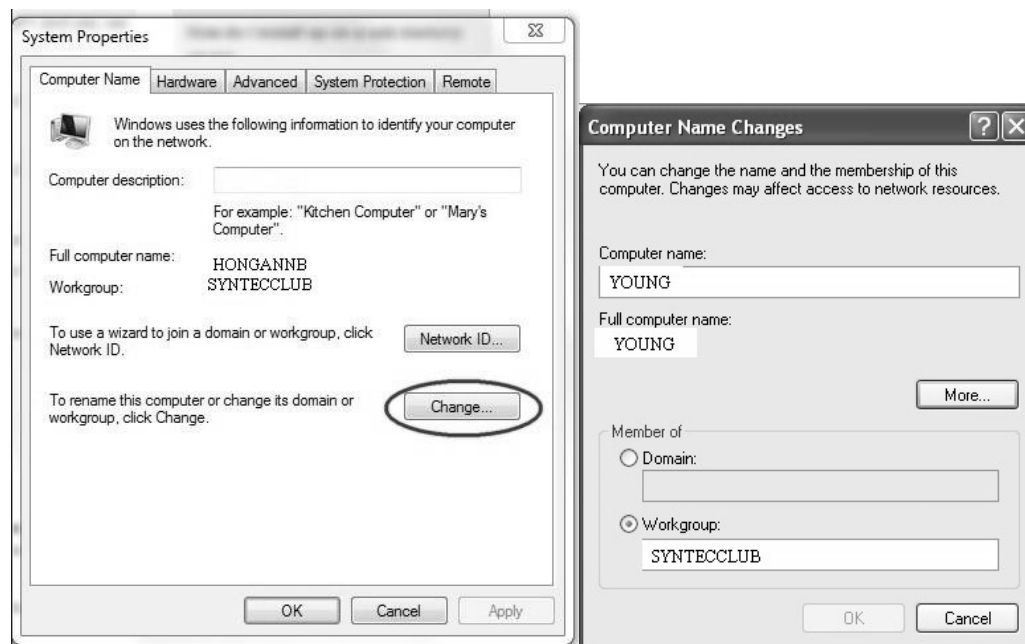

5. TCP/IP Setting

- a. “START” → “control panel” → “Network and sharing center”→“Network connection manager” → “Properties”

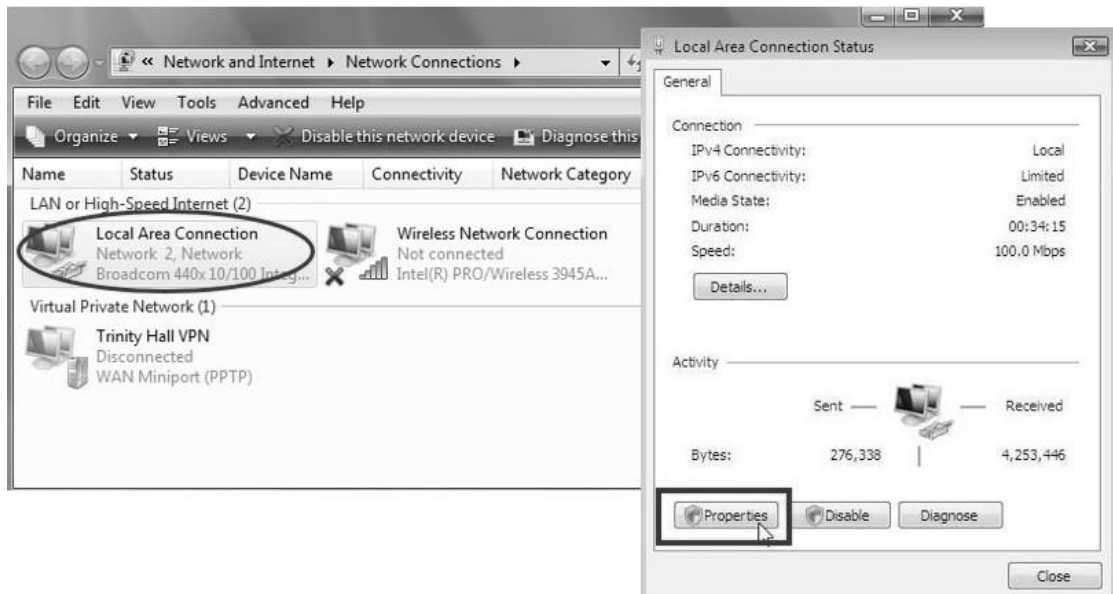

- b. Select “internet protocol(TCP/IP)” as shown below:
 - ✧ Jumper cable (without HUB), select “use the following IP address” and enter IP address (the forth number is different from controller setting) and Subnet mask (same with controller setting)
 - ✧ Network cable (with HUB), select”Obtain an IP address automatically”

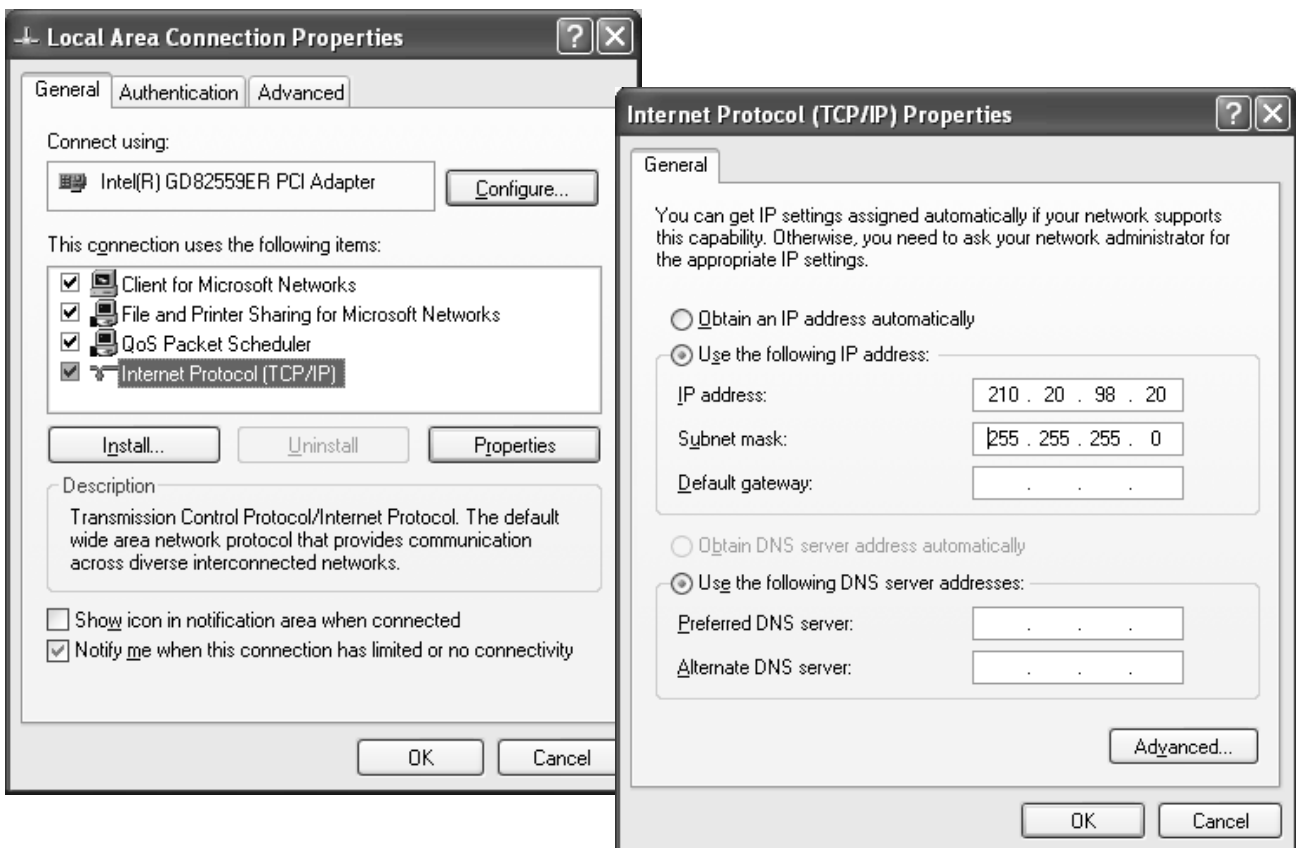

3.7.3 Win 7 OS

1. Sharing resource setting

- ✧ Right-click on folder wants to share, select “share with” and “specfic people”
- ✧ Share this folder to everyone, and then click “Share” as follows.
- ✧ Set permission as write/read

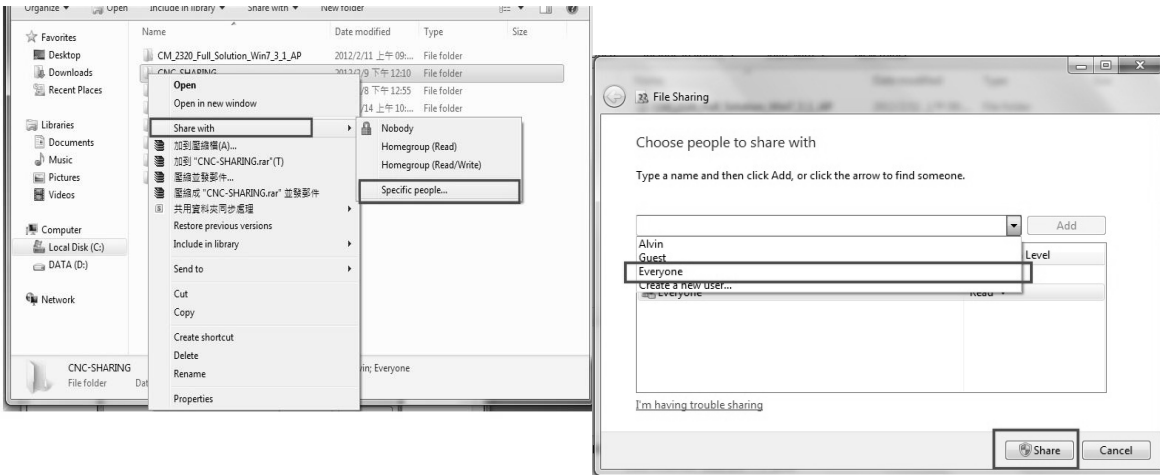

- ✧ Left-click on “advanced sharing”and select “share this folder”

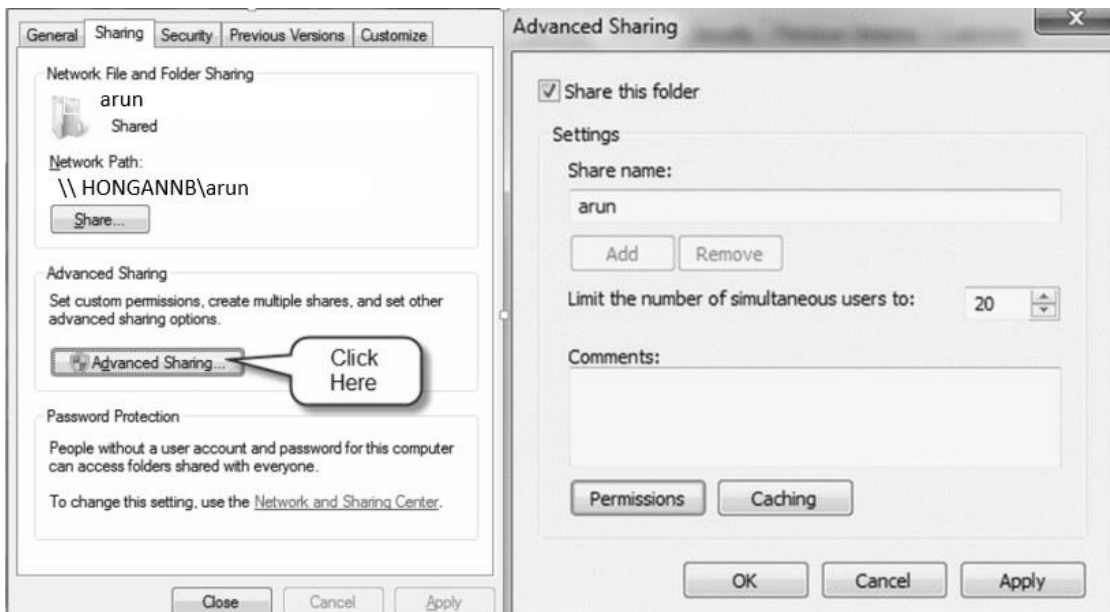

- ✧ Select “permission” and select “full control” “only read”and “change”

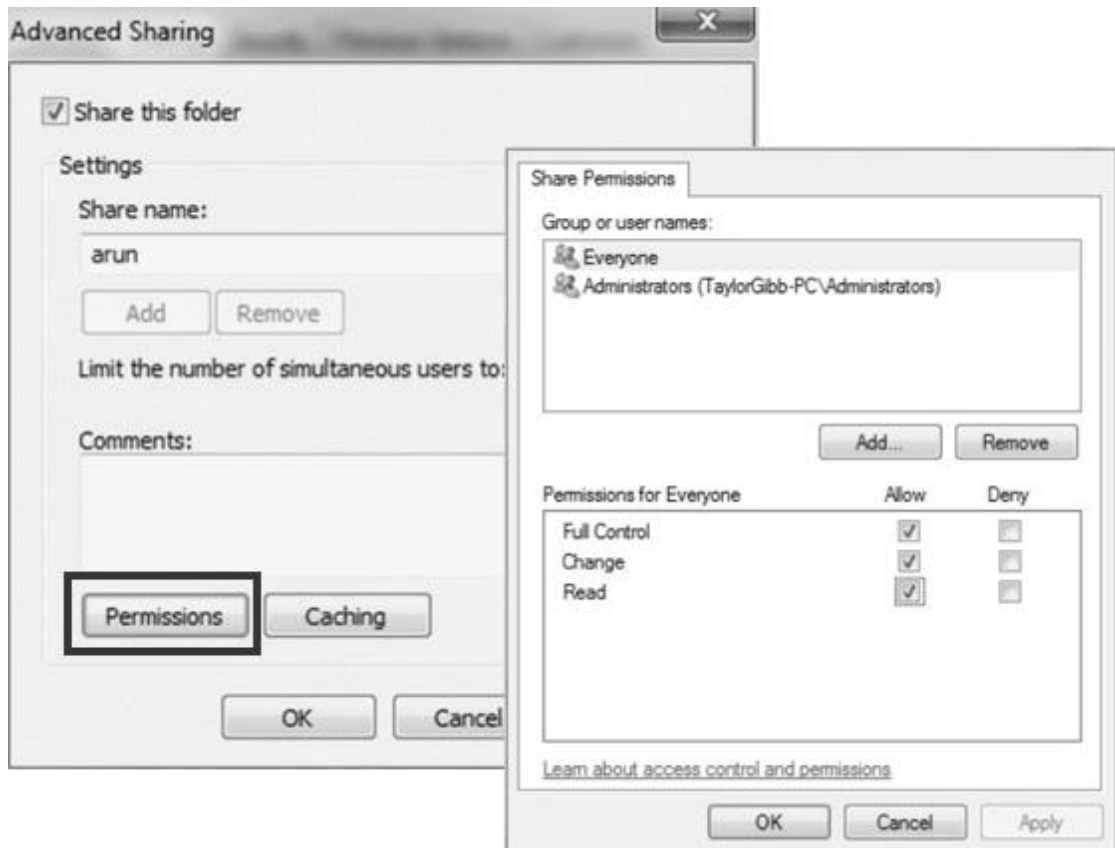

- ✧ Open”Network and sharing center”, select “turn off password protected sharing” and “Open sharing.....”

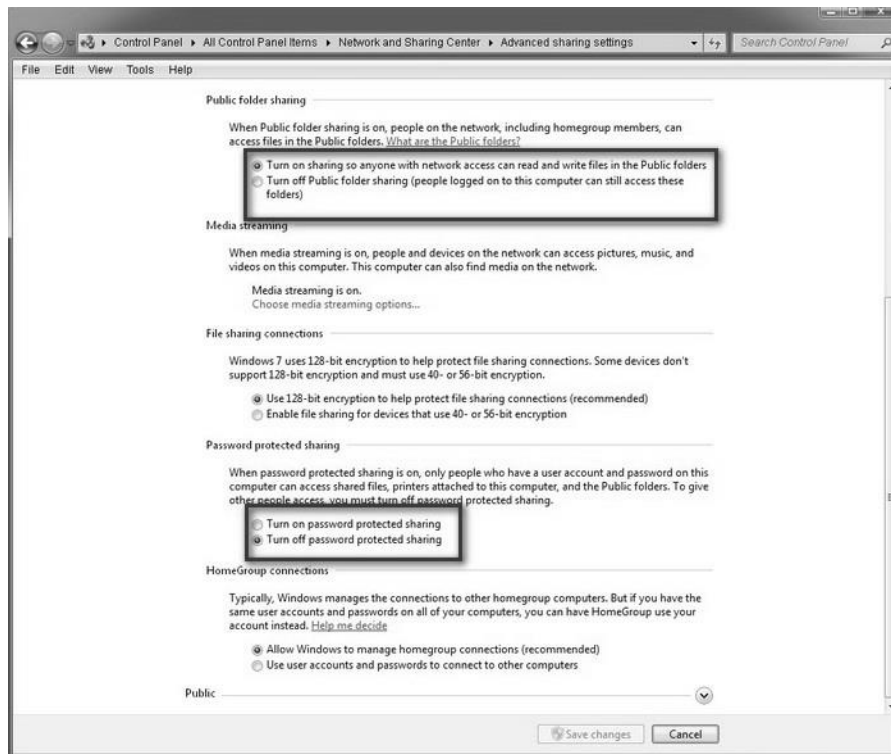

2. Setting PC name and workgroup

“Start”→ “control panel”→”system and security”→ ”System”→ "change " to set "Computer Name" and "Workgroup", remember these setting contents to use later on when setting controller.



3. TCP/IP Setting

- Double click “Internet Protocol Version 4 (TCP/IPv4)”
- Jumper cable(without HUB), select “use the following IP address” and enter IP address(the forth number is different from controller setting) and Subnet mask(same with controller setting)
- Network cable(with HUB), select ”Obtain an IP address automatically”

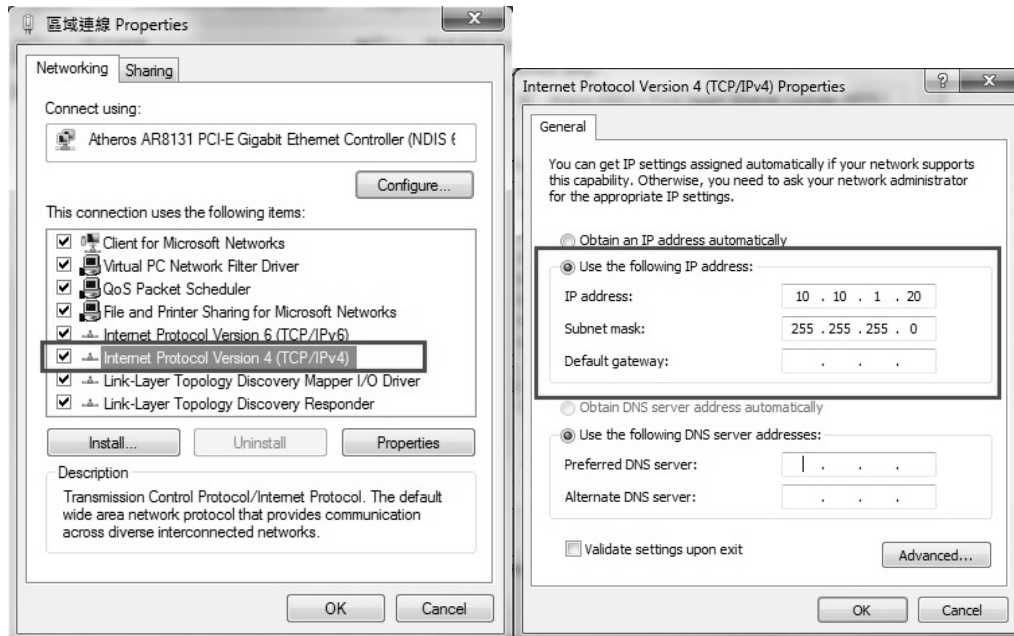

3.8 File Transfer

This section will show how to transfer files, files transfer is divided into import and export files, allowing controller share files to external devices, such as USB, CF card or users on the network.

3.8.1 File Import

- Operation

- ✧ Path: F2-program → F4-file manager → F4-file transfer → F1-File import
- ✧ Other interface will appear on screen, press F5-“device change” to move cursor to desired external device on the status bar
- ✧ Press [Enter] key to access to inside device, if the device icon has red cross, which means that there is no connection to this device,
- ✧ Select the file wants to import and press [Copy] to complete import file
- ✧ Press F4 cancel select to cancel the selected file
- ✧ After complete file transfer, press [left] or [ESC] to leave this screen

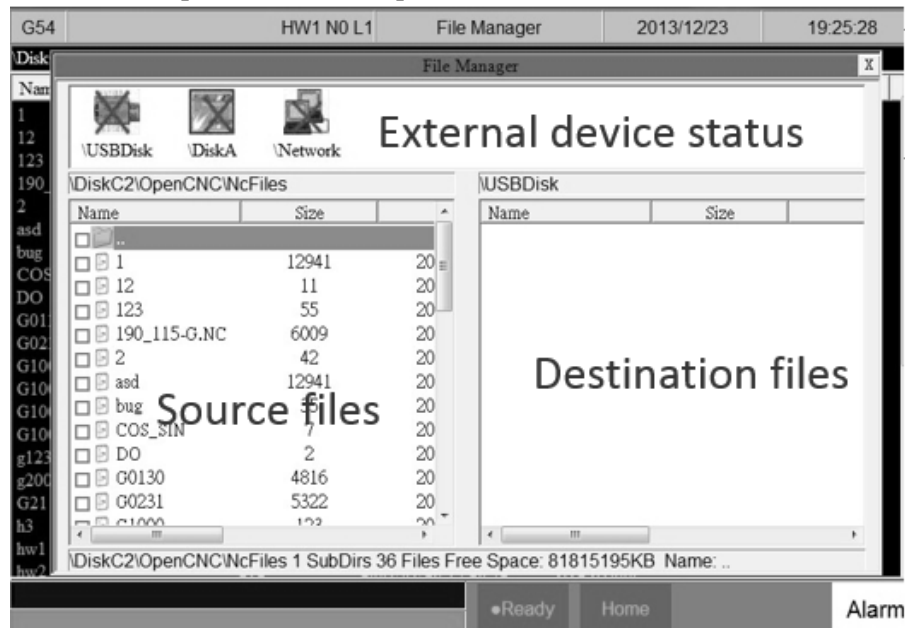

3.8.2 File Export

- Operation

- ✧ Path: F2-program → F4-file manager → F4-file transfer → F2-File export
- ✧ Other interface will appear on screen, press F5-device change to move cursor to desired external device on the status bar
- ✧ Press [Enter] key to access to inside device, if the device icon has red cross, which means that there is no connection to this device, Select the file wants to export and press [Copy] to complete export file
- ✧ Press F4 cancel select to cancel the selected file
- ✧ After complete file transfer, press [left] or [ESC] to leave this screen
- ✧ Note: if destination of export file does not exist, below alarm will appear

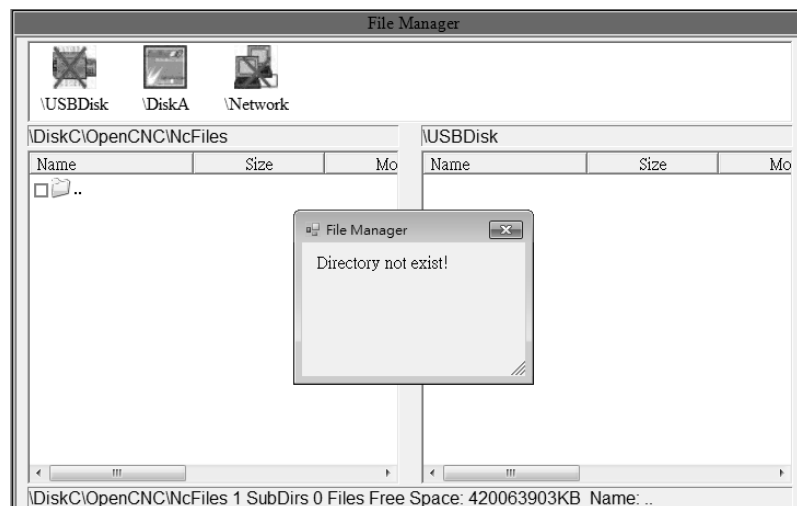

4 Appendix

4.1 Release Note

Doc. Ver.	Content	Release Date	Author	Reviewer	CN C Ver.
1.0	1 st Version	2013/11/20	Andy Ngo	許維中	1.0.1 4
1.1	Modify Composition	2014/01/09	Sandy. Duan	張宏安	1.0.1 4
1.2	Modify [WorkPiece Cord] key	2014/03/02	Andy Ngo	張宏安	2.2.2
1.3	Add Chinese topic, and increase front size	2015/11/13	Linda Chen	Yu-An Chiang	
05					

4.2 Contact Window

<p>Hsinchu Headquarters Tel : +886-3-6663553 Fax : +886-3-6663505 E-Mail : syntec@syntecclub.com.tw Address : No.21, Industry E.Rd. 4, Hsinchu Science Park 30077,Taiwan,R.O.C</p>	<p>Jiangsu-Suzhou SYNTEC Equipment CO.,Ltd. TEL : +86-512-69008860 FAX : 0512-69560818 Address : D 1-8,Teng Fei New Industrial Zone, 5# Xing Han Street, Suzhou Industrial Park, China</p>
<p>Taichung Taichung Service Agency TEL : +886-4-25337731 FAX : +886-4-25349224 Address : No.31, Alley 9, Lane 271, Shepi Rd., Fengyuan City, Taichung County 420, Taiwan, R.O.C</p>	<p>Taichung Taichung Service Agency TEL : +886-4-23102626 FAX : +886-4-23102636 Address : No.42, Jingming St., West Dist., Taichung City 403, Taiwan</p>
<p>Tainan Tainan Service Agency TEL : +886-6-2796707 FAX : +886-6-2796705 Address : No.218, Denan Rd., Rende Dist., Tainan City 71756, Taiwan</p>	<p>Jiangsu-SuZhou Suzhou Huaxin Numerical Control Technology Development CO.,LTD TEL : 0512-69560828 FAX : 0512-69560818 Address : Xing Han Street, Suzhou Industrial Park, Jiangsu Province, to take off the new Su Industrial Square D, 2nd Floor 01-08 unit</p>
<p>Zhejiang-Hangzhou SuZhou SYNTEC Equipment CO.,Ltd. Hangzhou Branch TEL : +86-571-82751187 FAX : +-86-571-82751186 Address : Room1202 Unit2 Buiding1, Edifice DiKai , Jincheng Road, Beigan Street,Xiaoshan District , Hangzhou City,Zhejiang</p>	<p>Zhejiang-Ningbo SuZhou SYNTEC Equipment CO.,Ltd. Ningbo Branch Ningbo City. TEL : +86-574-87750305 FAX : +86-574-87750306 Address : Room 12-07,No.262,416 Alley,Zhaohui Road,Jiangdong District,</p>

Province, China	
<p>Zhejiang-Wenling The Suzhou new generation of CNC Equipment Co., Ltd. Wenling Branch TEL : 0576- 86138372 FAX : 0576-86119106 Address : Room 1206, Department A, Zhenxing Plaza, Taiping Subdistrict, Wenling City</p>	<p>Guangdong-Guangzhou SuZhou SYNTEC Equipment CO.,Ltd. Guangzhou Branch TEL : +86-20-34583040 FAX : +86-20-34583220 Address : Room 403 Stairs1 Youyi Building!ALuojia Village 8,Fuyi Road,ShijiTown,Panyu Distrcet,Guangzhou City,Guangdong Province, China</p>
<p>Guangdong-Dongguan SuZhou SYNTEC Equipment CO.,Ltd. Dongguan Branch TEL : +86-769-81660318 FAX : +86-769-81660328 Address : Room 705 JinGuo Business affairs centre Xin an District Chang an</p>	<p>Shaanxi-Xi'an The Suzhou new generation of CNC Equipment Co., Ltd. Xi'an Office TEL : 029-88287423 FAX : 029-88287423 Address : Room 2503,Unit 1,Rancho Santa Fe,No.36, Dianzi Third Road, Yanta District, Xi'an, Shaanxi</p>
<p>Shaanxi-Baoji The Suzhou new generation CNC Equipment Co., Ltd. Baoji offices TEL : 18700712118 Address : Room 2401, Building 1, Xinjian Road, Weibin District, Baoji</p>	<p>Shandong-Jinan SuZhou SYNTEC Equipment CO.,Ltd. Jinan Branch TEL : +86-53185907208 FAX : +86-53185905708 Address : Room 1112, Unit A, Jiahui Global Plaza, No.548, Beiyuan Street, Tianqiao District, Jinan, China</p>
<p>Fujian-Xiamen SuZhou SYNTEC Equipment CO.,Ltd. Xiamen Branch TEL : +86-592-7191901 FAX : +86-592-7220536 Address : No. 100,B Chuang Chang Fang 3F East,Jin Fu Road,Tong An District,Xiamen City, Fujian</p>	<p>Tianjin The Suzhou new generation of CNC Equipment Co., Ltd. Tianjin Branch TEL : +86-22-87134111 FAX : 022-87134111 Address : Tianjin Huayuan Industrial Zone, Rong Yuan Road No. 4 day</p>

SYNTEC

Province, China	science and Technology Park Building No. 1, 2 door 501
Henan-Luoyang The Suzhou new generation of CNC Equipment Co., Ltd. Luoyang Company TEL : 0379-65110352 FAX : 0379-65110352 Address : 601B, Runsheng Building, Cross of Sanshan Road & Heluo Road, Hi-and-New Tech Park of Luoyang, Henan	Chongqing The Suzhou new generation of CNC Equipment Co., Ltd. Chongqing Branch TEL : 023-67913296 FAX : 023-67634382 Address : Room 41-4, Building A, Hongding International, Guanyinqiao, Jiangbei District, Chongqing
Jiangsu-Nanjing The Suzhou new generation of CNC Equipment Co., Ltd. Chongqing Branch TEL : 0512-69008860-300 Address : Room 505, Unit 3, Building 12,Wuyi Luzhou Guan Chu Yuan, No.99, Tianyuan Middle Road, Jiangning District, Nanjing	Hubei-Wuhan Suzhou new generation of CNC Equipment Co., Ltd. Wuhan Office TEL : 027-87638876 FAX : 027-87204137 Address : Room2003-2006,A#Guangguguo ji,456#Luoyu Road,Donghukaifaqu,Wuhan City, China
Shenyang The Suzhou new generation CNC Equipment Co., Ltd. Shenyang Office TEL : 024-25821398 FAX : 024-25821398	Anhui-Hefei The new generation of CNC Equipment Co., Ltd. in Suzhou, Hefei Office TEL : 15951989576 Address : Room 704, Building 13,Wanzhen Xiaoyao Garden IV, Taihu East Road, Hefei
Shenzhen Shenzhen branch District, Sham Chun City, Guandong Province TEL : 0755-84584085 Address : Room 706, Hsin Toun Building,	Thailand SIAM RADERMEN Co., Ltd. TEL : +66-27553536 FAX : +66-27575476 E-Mail : lee_cheahow@yahoo.com Address :

<p>Toun Chung Road, Ai Lian Hsin Toun Village, Logan</p>	<p>52/4,MOO5,THEPARAK RD.(KM11.5)BANGPLEEYAI,B ANGPLEE, SAMUTPRAKRAN 10540</p>
<p>Malaysia SURE FIRST ENTERPRISE (M) SDN BHD. TEL : +603-61577632 FAX : +603-61574632 Address : 47000 NO 19.JALAN TSB 6,TAMAN INDUSTRI SUNGAI BULOH.47000 SELANGOR DARUL.EHSAN</p>	<p>Lebanon / Damascus Kesmeyan Group Co. Lebanon Beirut, Jdeideh - Ammaieh - Kessmeyan Group Build. Damascus TEL: +963 11 6731602 Mob.: +963 988 211407 E-Mail : info@rockwell.tw TEL : +961-76-883778 FAX : +961-1-901807 E-Mail : kesmeyan@rockwell.tw</p>
<p>France INTEGRATION CNC TEL : +33 2 35 06 07 83 FAX : +33 2 35 06 07 83 http://www.integrationcnc.fr/ E-Mail : vaque.j@online.fr Address : 6, Rue l'arché de Copigny, 76630 BAILLY, FRANCE</p>	<p>Turkey KASIKCIOGLU ELEKTROMEKANIK OTOMASYON TEL : +90-224-4434684 FAX : +90-224-4434685 E-Mail : murat@kasikcioglu.com Address : Besevler K.S.S. 17 BLOK NO:72 Nilufer/BURSA/TURKYIE</p>
<p>ISTANBUL/TURKEY AKSIS MAKINA TEL : +90 212 613 87 83 FAX : +90 212 613 87 85 http://www.aksismakina.com E-Mail : info@aksismakina.com Address : Yeni doğan mahallesi karakaş Sk. Emintaş Erciyes Sanayi Sitesi no:12/206</p>	

SYNTEC

<p>Hsinchu Headquarters Tel : +886-3-6663553 Fax : +886-3-6663505 E-Mail : syntec@syntecclub.com.tw Address : No.21, Industry E.Rd. 4, Hsinchu Science Park 30077,Taiwan,R.O.C</p>	<p>Jiangsu-Suzhou SYNTEC Equipment CO.,Ltd. TEL : +86-512-69008860 FAX : 0512-69560818 Address : D 1-8,Teng Fei New Industrial Zone, 5# Xing Han Street, Suzhou Industrial Park, China</p>
<p>Taichung Taichung Service Agency TEL : +886-4-25337731 FAX : +886-4-25349224 Address : No.31, Alley 9, Lane 271, Shepi Rd., Fengyuan City, Taichung County 420, Taiwan, R.O.C</p>	<p>Taichung Taichung Service Agency TEL : +886-4-23102626 FAX : +886-4-23102636 Address : No.42, Jingming St., West Dist., Taichung City 403, Taiwan</p>
<p>Tainan Tainan Service Agency TEL : +886-6-2796707 FAX : +886-6-2796705 Address : No.218, Denan Rd., Rende Dist., Tainan City 71756, Taiwan</p>	<p>Jiangsu-SuZhou Suzhou Huaxin Numerical Control Technology Development CO.,LTD TEL : 0512-69560828 FAX : 0512-69560818 Address : Xing Han Street, Suzhou Industrial Park, Jiangsu Province, to take off the new Su Industrial Square D, 2nd Floor 01-08 unit</p>
<p>Zhejiang-Hangzhou SuZhou SYNTEC Equipment CO.,Ltd. Hangzhou Branch TEL : +86-571-82751187 FAX : +-86-571-82751186 Address : Room1202 Unit2 Buiding1, Edifice DiKai , Jincheng Road, Beigan Street,Xiaoshan District , Hangzhou City,Zhejiang Province, China</p>	<p>Zhejiang-Ningbo SuZhou SYNTEC Equipment CO.,Ltd. Ningbo Branch Ningbo City. TEL : +86-574-87750305 FAX : +86-574-87750306 Address : Room 12-07,No.262,416 Alley,Zhaohui Road,Jiangdong District,</p>
<p>Zhejiang-Wenling</p>	<p>Guangdong-Guangzhou</p>

<p>The Suzhou new generation of CNC Equipment Co., Ltd. Wenling Branch TEL : 0576- 86138372 FAX : 0576-86119106 Address : Room 1206, Department A, Zhenxing Plaza, Taiping Subdistrict, Wenling City</p>	<p>SuZhou SYNTEC Equipment CO.,Ltd. Guangzhou Branch TEL : +86-20-34583040 FAX : +86-20-34583220 Address : Room 403 Stairs1 Youyi Building!ALuojia Village 8,Fuyi Road,ShijiTown,Panyu Distrcet,Guangzhou City,Guangdong Province, China</p>
<p>Guangdong-Dongguan SuZhou SYNTEC Equipment CO.,Ltd. Dongguan Branch TEL : +86-769-81660318 FAX : +86-769-81660328 Address : Room 705 JinGuo Business affairs centre Xin an District Chang an</p>	<p>Shaanxi-Xi'an The Suzhou new generation of CNC Equipment Co., Ltd. Xi'an Office TEL : 029-88287423 FAX : 029-88287423 Address : Room 2503,Unit 1,Rancho Santa Fe,No.36, Dianzi Third Road, Yanta District, Xi'an, Shaanxi</p>
<p>Shaanxi-Baoji The Suzhou new generation CNC Equipment Co., Ltd. Baoji offices TEL : 18700712118 Address : Room 2401, Building 1, Xinjian Road, Weibin District, Baoji</p>	<p>Shandong-Jinan SuZhou SYNTEC Equipment CO.,Ltd. Jinan Branch TEL : +86-53185907208 FAX : +86-53185905708 Address : Room 1112, Unit A, Jiahui Global Plaza, No.548, Beiyuan Street, Tianqiao District, Jinan, China</p>
<p>Fujian-Xiamen SuZhou SYNTEC Equipment CO.,Ltd. Xiamen Branch TEL : +86-592-7191901 FAX : +86-592-7220536 Address : No. 100,B Chuang Chang Fang 3F East,Jin Fu Road,Tong An District,Xiamen City, Fujian Province, China</p>	<p>Tianjin The Suzhou new generation of CNC Equipment Co., Ltd. Tianjin Branch TEL : +86-22-87134111 FAX : 022-87134111 Address : Tianjin Huayuan Industrial Zone, Rong Yuan Road No. 4 day science and Technology Park Building No. 1, 2 door 501</p>

SYNTEC

<p>Henan-Luoyang The Suzhou new generation of CNC Equipment Co., Ltd. Luoyang Company TEL : 0379-65110352 FAX : 0379-65110352 Address : 601B, Runsheng Building, Cross of Sanshan Road & Heluo Road, Hi-and-New Tech Park of Luoyang, Henan</p>	<p>Chongqing The Suzhou new generation of CNC Equipment Co., Ltd. Chongqing Branch TEL : 023-67913296 FAX : 023-67634382 Address : Room 41-4, Building A, Hongding International, Guanyinqiao, Jiangbei District, Chongqing</p>
<p>Jiangsu-Nanjing The Suzhou new generation of CNC Equipment Co., Ltd. Chongqing Branch TEL : 0512-69008860-300 Address : Room 505, Unit 3, Building 12, Wuyi Luzhou Guan Chu Yuan, No.99, Tianyuan Middle Road, Jiangning District, Nanjing</p>	<p>Hubei-Wuhan Suzhou new generation of CNC Equipment Co., Ltd. Wuhan Office TEL : 027-87638876 FAX : 027-87204137 Address : Room2003-2006,A#Guangguguoji,456#Luoyu Road,Donghukaifaqu,Wuhan City, China</p>
<p>Shenyang The Suzhou new generation CNC Equipment Co., Ltd. Shenyang Office TEL : 024-25821398 FAX : 024-25821398</p>	<p>Anhui-Hefei The new generation of CNC Equipment Co., Ltd. in Suzhou, Hefei Office TEL : 15951989576 Address : Room 704, Building 13, Wanzhen Xiaoyao Garden IV, Taihu East Road, Hefei</p>
<p>Shenzhen Shenzhen branch District, Sham Chun City, Guandong Province TEL : 0755-84584085 Address : Room 706, Hsin Toun Building, Toun Chung Road, Ai Lian Hsin Toun Village, Loggan</p>	<p>Thailand SIAM RADERMEN Co., Ltd. TEL : +66-27553536 FAX : +66-27575476 E-Mail : lee_cheahow@yahoo.com Address : 52/4,MOO5,THEPARAK RD.(KM11.5)BANGPLEEYAI,B</p>

	ANGPLEE, SAMUTPRAKRAN 10540
Malaysia SURE FIRST ENTERPRISE (M) SDN BHD. TEL : +603-61577632 FAX : +603-61574632 Address : 47000 NO 19.JALAN TSB 6,TAMAN INDUSTRI SUNGAI BULOH.47000 SELANGOR DARUL.EHSAN	Lebanon / Damascus Kesmeyan Group Co. Lebanon Beirut, Jdeideh - Ammaieh - Kessmeyan Group Build. Damascus TEL: +963 11 6731602 Mob.: +963 988 211407 E-Mail : info@rockwell.tw TEL : +961-76-883778 FAX : +961-1-901807 E-Mail : kesmeyan@rockwell.tw
France INTEGRATION CNC TEL : +33 2 35 06 07 83 FAX : +33 2 35 06 07 83 http://www.integrationcnc.fr/ E-Mail : vaque.j@online.fr Address : 6, Rue l'arché de Copigny, 76630 BAILLY, FRANCE	Turkey KASIKCIOGLU ELEKTROMEKANIK OTOMASYON TEL : +90-224-4434684 FAX : +90-224-4434685 E-Mail : murat@kasikcioglu.com Address : Besevler K.S.S. 17 BLOK NO:72 Nilufer/BURSA/TURKYIE
ISTANBUL/TURKEY AKSIS MAKINA TEL : +90 212 613 87 83 FAX : +90 212 613 87 85 http://www.aksismakina.com E-Mail : info@aksismakina.com Address : Yeni doğan mahallesi karakaş Sk. Emintaş Erciyes Sanayi Sitesi no:12/206	
Hsinchu Headquarters Tel : +886-3-6663553	Suzhou SYNTEC Equipment CO.Ltd

SYNTEC

<p>Fax : +886-3-6663505 E-Mail : syntec@syntecclub.com.tw Address : No.21, Industry E.Rd. 4, Hsinchu Science Park 30077,Taiwan,R.O.C</p>	<p>Tel : 0512-69008860 Fax : 0512-65246029 Address : D1-8, Teng Fei New Industriak Zone, 5# Xing Han Street, Suzhou Industrial Park, China</p>
<p>Guangdong-Dongguan SuZhou SYNTEC Equipment CO.,Ltd. Dongguan Branch Tel : 0769-81660318 Fax : 0769-81660328 Address : Room 705 JinGuo Business affairs centre Xin an District Chang an</p>	<p>Guangdong-Guangzhou SuZhou SYNTEC Equipment CO.,Ltd. Guangzhou Branch Tel : 020-34583040 Fax : 020-34583220 Address : Room 403 Stairs1 Youyi Building!ALuojia Village 8,Fuyi Road,ShijiTown,Panyu Distrcet,Guangzhou City,Guangdong Province, China</p>
<p>Zhejiang-Hangzhou SuZhou SYNTEC Equipment CO.,Ltd. Hangzhou Branch Tel : 0571-82751187 Fax : 0571-82751186 Address : Room1202 Unit2 Buiding1, Edifice DiKai , Jincheng Road, Beigan Street,Xiaoshan District , Hangzhou City,Zhejiang Province, China</p>	<p>Zhejiang-Ningbo SuZhou SYNTEC Equipment CO.,Ltd. Ningbo Branch Tel : 0574-87750305 Fax : 0574-87750306 Address : Room 12-07,No.262,416 Alley,Zhaohui Road,Jiangdong District, Ningbo City.</p>
<p>Jiangsu-Suzhou SYNTEC Equipment CO.,Ltd. Tel : 0512-69008890 Fax : 0512-69560818 Address : D 1-8,Teng Fei New Industrial Zone, 5# Xing Han Street, Suzhou Industrial Park, China</p>	<p>Shandong-Jinan SuZhou SYNTEC Equipment CO.,Ltd. Jinan Branch Tel : 0531-85907208 Fax : 0531-85905708 Address : Room 1112, Unit A, Jiahui Global Plaza, No.548, Beiyuan Street, Tianqiao District, Jinan, China</p>
<p>Fujian-Xiamen SuZhou SYNTEC Equipment</p>	<p>Tianjin The Suzhou SYNTEC Equipment</p>

<p>CO.,Ltd. Xiamen BranchTel : 0592-7191901 Fax : 0592-7220536 Address : No. 100,B Chuang Chang Fang 3F East,Jin Fu Road,Tong An District,Xiamen City, Fujian Province, China</p>	<p>Co., Ltd. Tianjin BranchTel : 022-87134111 Fax : 022-87134111 Address : Haiyi International 3-1416, No.2, Rongyuan Road, Huayuan Industries Park, Binhai Hi-and-New Tech Park, Tianjin</p>
<p>Chongqing Branch Tel : 023-67913296 Fax : 023-67913296 Address : Room 41-4, Building A, Hongding International, Guanyinqiao, Jiangbei District, Chongqing</p>	<p>Henan-Luoyang Tel : 18603795742 Fax : 0379-64319147 Address : 601B, Runsheng Building, Cross of Sanshan Road & Heluo Road, Hi-and-New Tech Park of Luoyang, Henan</p>
<p>Zhejiang-Wenling Tel : 0576-86119106 Fax : 0576-86119106 Address : Room 1206, Department A, Zhenxing Plaza, Taiping Subdistrict, Wenling City</p>	<p>Jiangsu-Nanjing Tel : 15051456229 0512-69008860-300 Address : Room 505, Unit 3, Building 12,Wuyi Luzhou Guan Chu Yuan, No.99, Tianyuan Middle Road, Jiangning District, Nanjing</p>
<p>Shaanxi-Xi'an Tel : 029-88287423 Fax : 029-88287423 Address : Room 2503,Unit 1,Rancho Santa Fe,No.36, Dianzi Third Road, Yanta District, Xi'an, Shaanxi</p>	<p>Shaanxi - Baoji Tel : 15896289717 Address :</p>
<p>Hubei-Wuhan Tel : 027-87638876 Fax : 027-87204137 Address: Room2003-2006,A#Guangguguoji,456#Luoyu Road,Donghukaifaqu,Wuhan City, China</p>	<p>Anhui-Hefei Tel : 15951989576 Address : Room 704, Building 13,Wanzhen Xiaoyao Garden IV, Taihu East Road, Hefei</p>

SYNTEC

Liaoning-Shenyang Tel : 15002491395 18698806526 Address : No.3 A 1-12-3, South Wenhui Street, Shenhe District, Shenyang, Liaoning	Taiwan-Taichung sales agency Tel : +886-4-25337731 Fax : +886-4-25349224 Address : No31, Alley , Lane271, Shepi Rd., Fengyuan city, Taichung ounty 420, Taiwan
Taiwan-Taichung sales agency Tel : +886-4-23102626 Fax : +886-4-23102636 Address : No42. Jingming Rd, Taichung	Taiwan-TaicNan sales agency Tel : +886-6-2796707 Fax : +886-6-2796705 Address : No.218 Denan Rd, Rende Dist, Tainan city 71756, Taiwan